

KR 52 PPA SKF

Cam followers

TYPE: Roller bearings, Stud type track rollers, With axial guidance, sealing rings on both sides

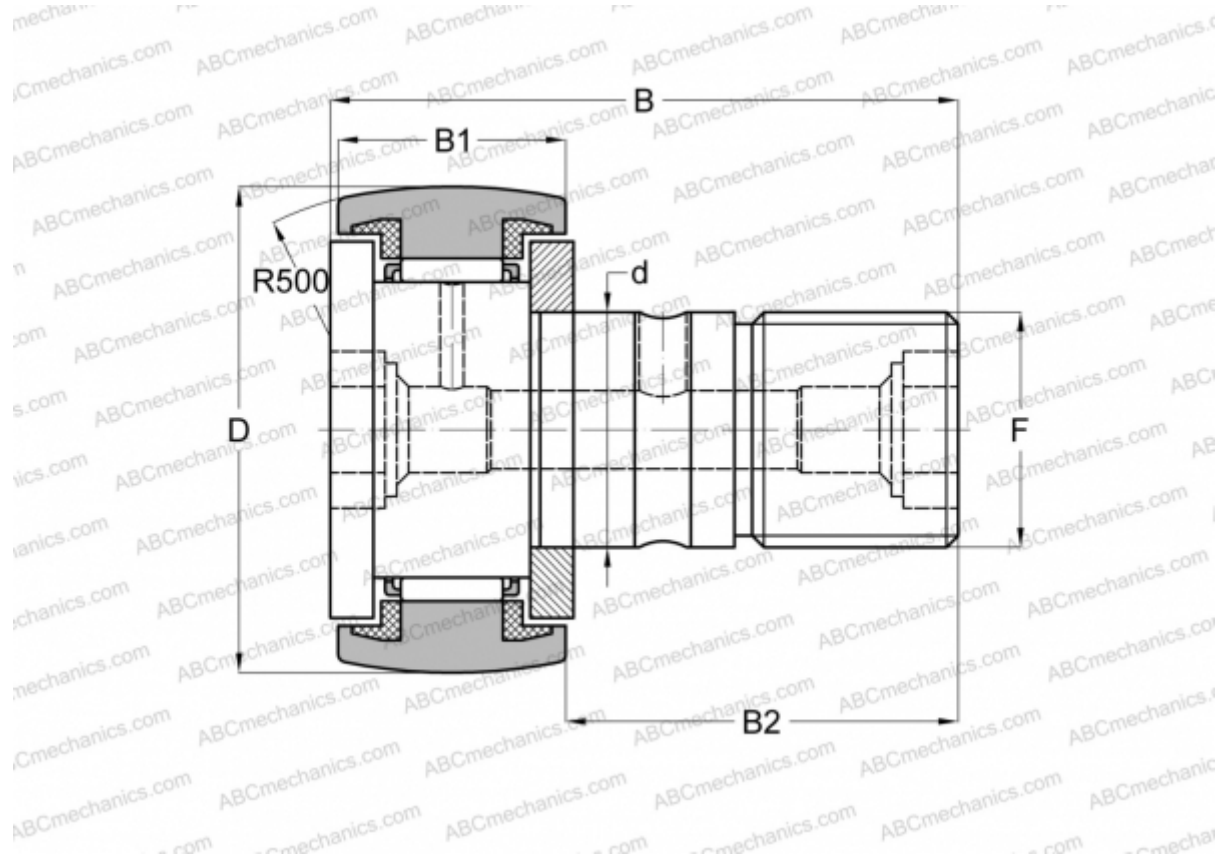

Technical specification

DIMENSIONS, MM

d	20,000
D	52,000
B	66,000
B1	24,000
B2	40,500
F	M 20x1.5

WEIGHT, KG 0,454

MANUFACTURER [SKF](#)

INTERCHANGE

ABC	KR 52 PP
INA	KR 52 PP
IKO	CF 20 UUR
McGill	MCFR-52-S

CALCULATION DATA

Basic dynamic load rating, C	15,700 kN
Basic static load rating, Co	27,000 kN
Fatigue load limit, Pu	3,200 kN
Limiting speed	3000 r/min