

MCFR-52-S McGill

Cam followers

TYPE: Roller bearings, Stud type track rollers, With axial guidance, sealing rings on both sides

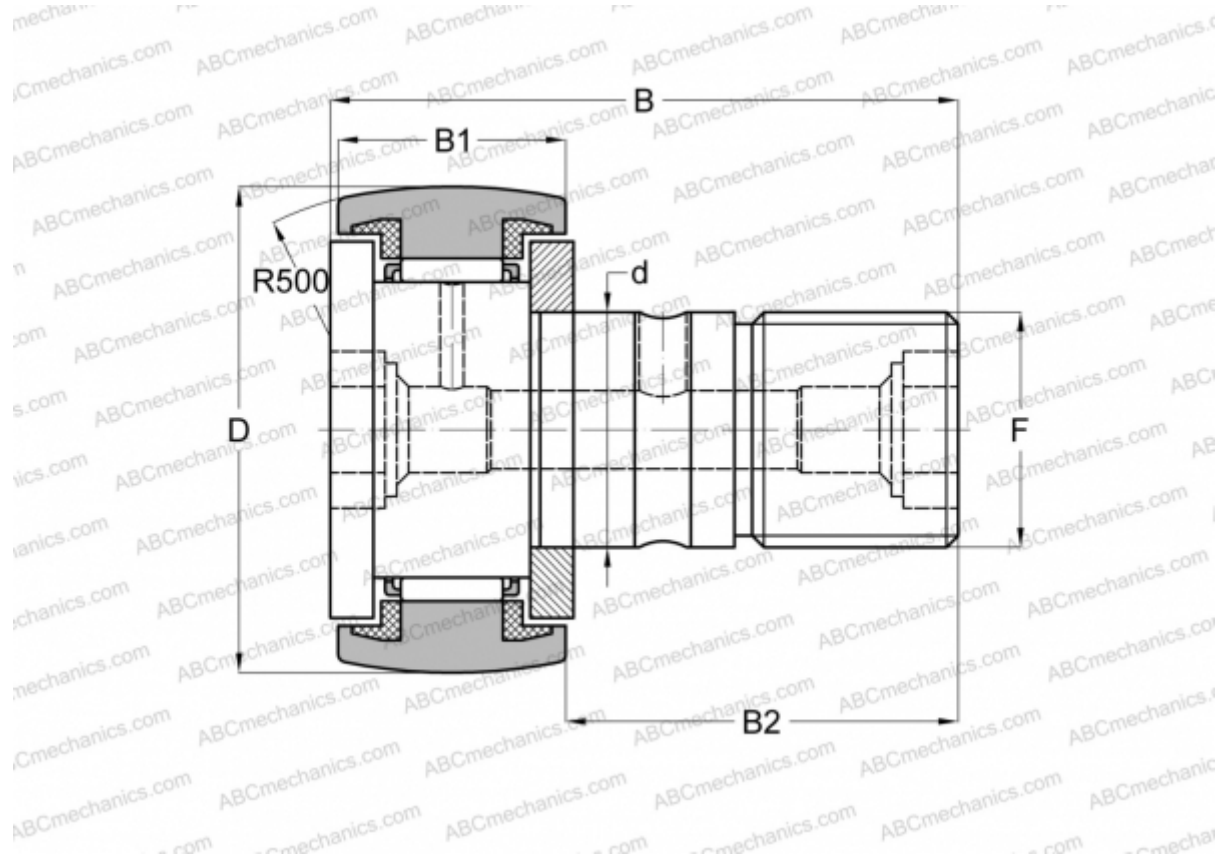

Technical specification

DIMENSIONS, MM

d	20,000
D	52,000
B	66,000
B1	24,000
B2	40,500
F	M20x1.5

WEIGHT, KG 0,473

MANUFACTURER [McGill](#)

INTERCHANGE

ABC	KR 52 PP
INA	KR 52 PP
SKF	KR 52 PPA
IKO	CF 20 UUR