

CF 24 UUR IKO

Cam followers

TYPE: Roller bearings, Stud type track rollers, With axial guidance, sealing rings on both sides

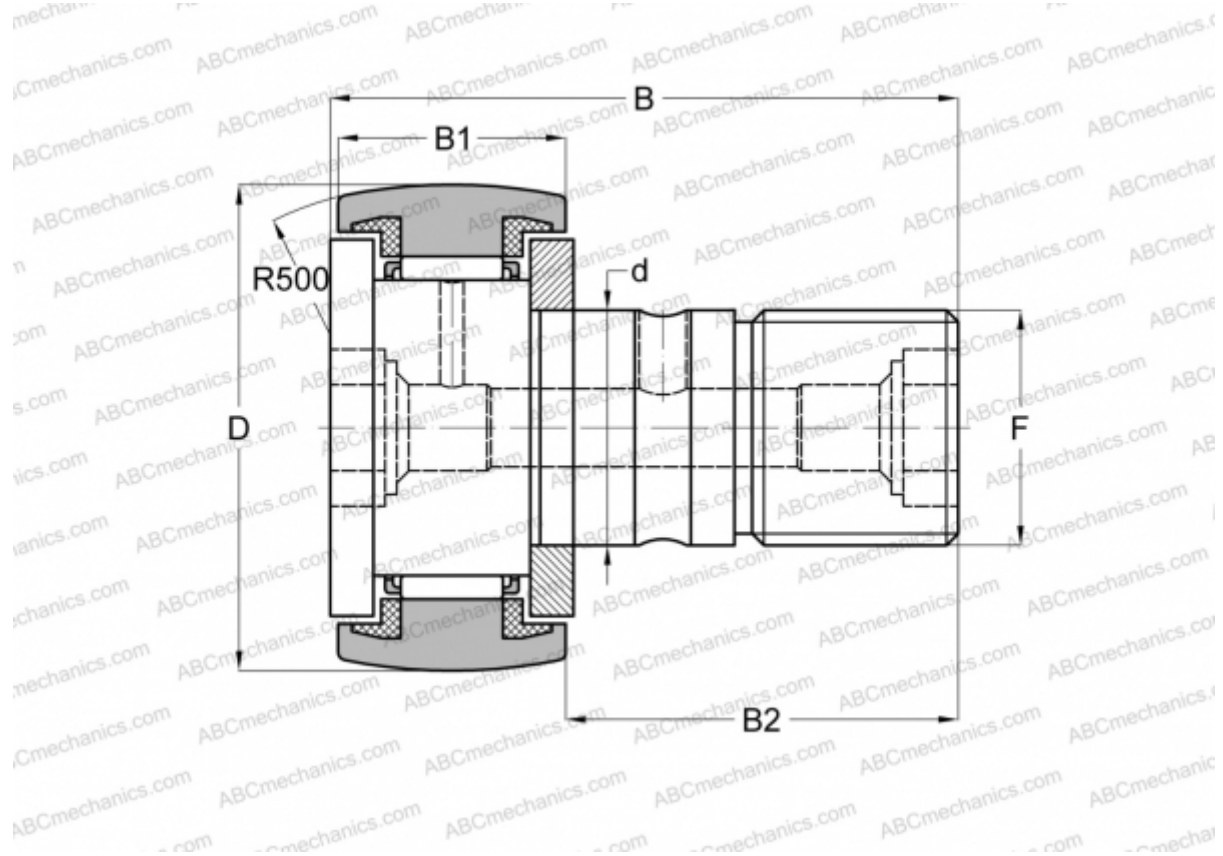

Technical specification

DIMENSIONS, MM

d	24,000
D	62,000
B	80,100
B1	29,000
B2	49,500
F	M24x1.5

WEIGHT, KG 0,815

MANUFACTURER [IKO](#)

INTERCHANGE

ABC	KR 62 PP
INA	KR 62 PP
SKF	KR 62 PPA
McGill	MCFR-62-S

CALCULATION DATA

Basic dynamic load rating, C	30,500 kN
Basic static load rating, Co	52,600 kN