

KR 72 PP INA

Cam followers

TYPE: Roller bearings, Stud type track rollers, With axial guidance, sealing rings on both sides

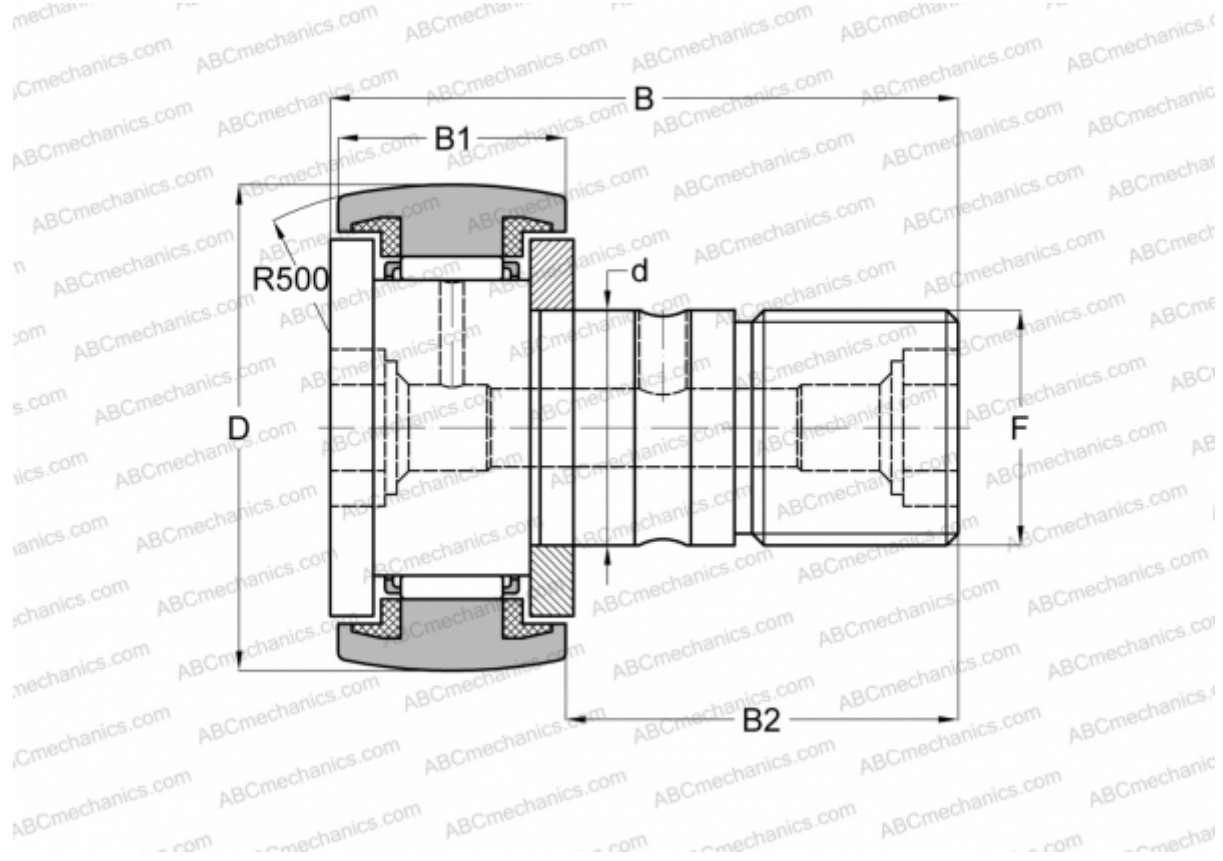

Technical specification

DIMENSIONS, MM

d	24,000
D	72,000
B	80,000
B1	29,000
B2	49,500
F	M24x1.5

WEIGHT, KG 1,038

MANUFACTURER [INA](#)

INTERCHANGE

ABC	KR 72 PP
SKF	KR 72 PPA
IKO	CF 24-1 UUR
McGill	MCFR-72-S