

KR 72 PPA SKF

Cam followers

TYPE: Roller bearings, Stud type track rollers, With axial guidance, sealing rings on both sides

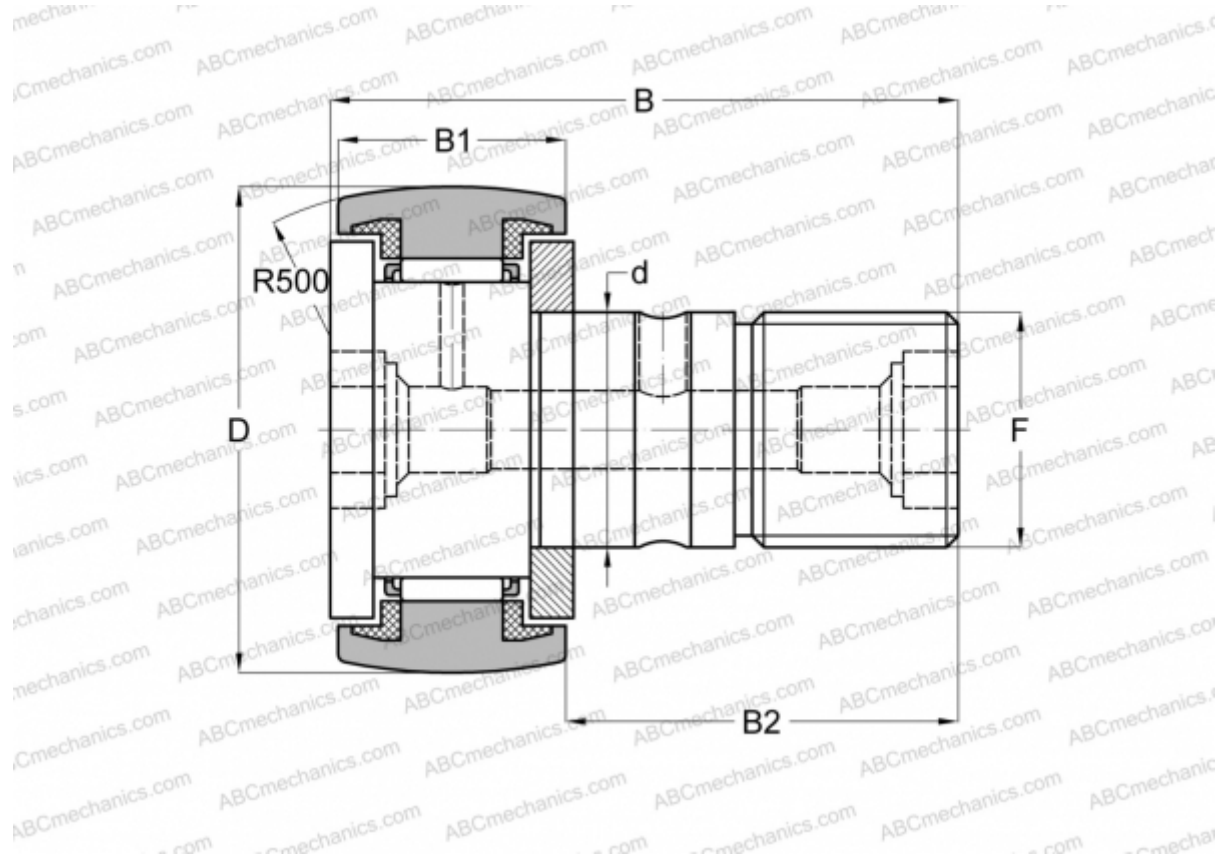

Technical specification

DIMENSIONS, MM

d	24,000
D	72,000
B	80,000
B1	29,000
B2	49,500
F	M 24x1.5

WEIGHT, KG 1,010

MANUFACTURER [SKF](#)

INTERCHANGE

ABC	KR 72 PP
INA	KR 72 PP
IKO	CF 24-1 UUR
McGill	MCFR-72-S

CALCULATION DATA

Basic dynamic load rating, C	26,000 kN
Basic static load rating, Co	48,000 kN
Fatigue load limit, Pu	6,000 kN
Limiting speed	2400 r/min