

CF 3 UU ABC

Cam followers

TYPE: Roller bearings, Stud type track rollers, With axial guidance, sealing rings on both sides, cylindrical outer ring

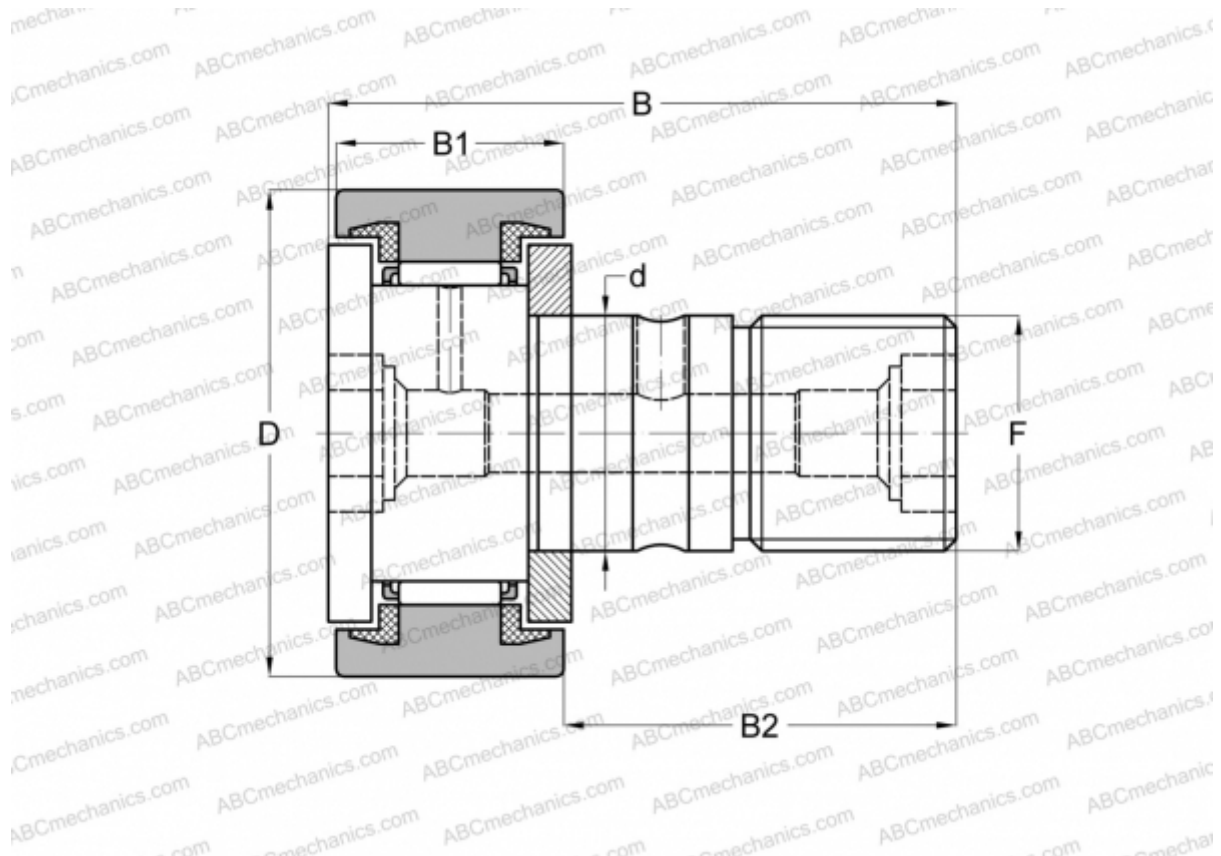

Technical specification

DIMENSIONS, MM

d	3,000
D	10,000
B	17,000
B1	7,000
B2	9,000
F	M3x0.5

WEIGHT, KG 0,004

MANUFACTURER [ABC](#)

INTERCHANGE

IKO	CF 3 UU
McGill	MCFR-10-SX