

KR 19 PPX ABC

Cam followers

TYPE: Roller bearings, Stud type track rollers, With axial guidance, sealing rings on both sides, cylindrical outer ring

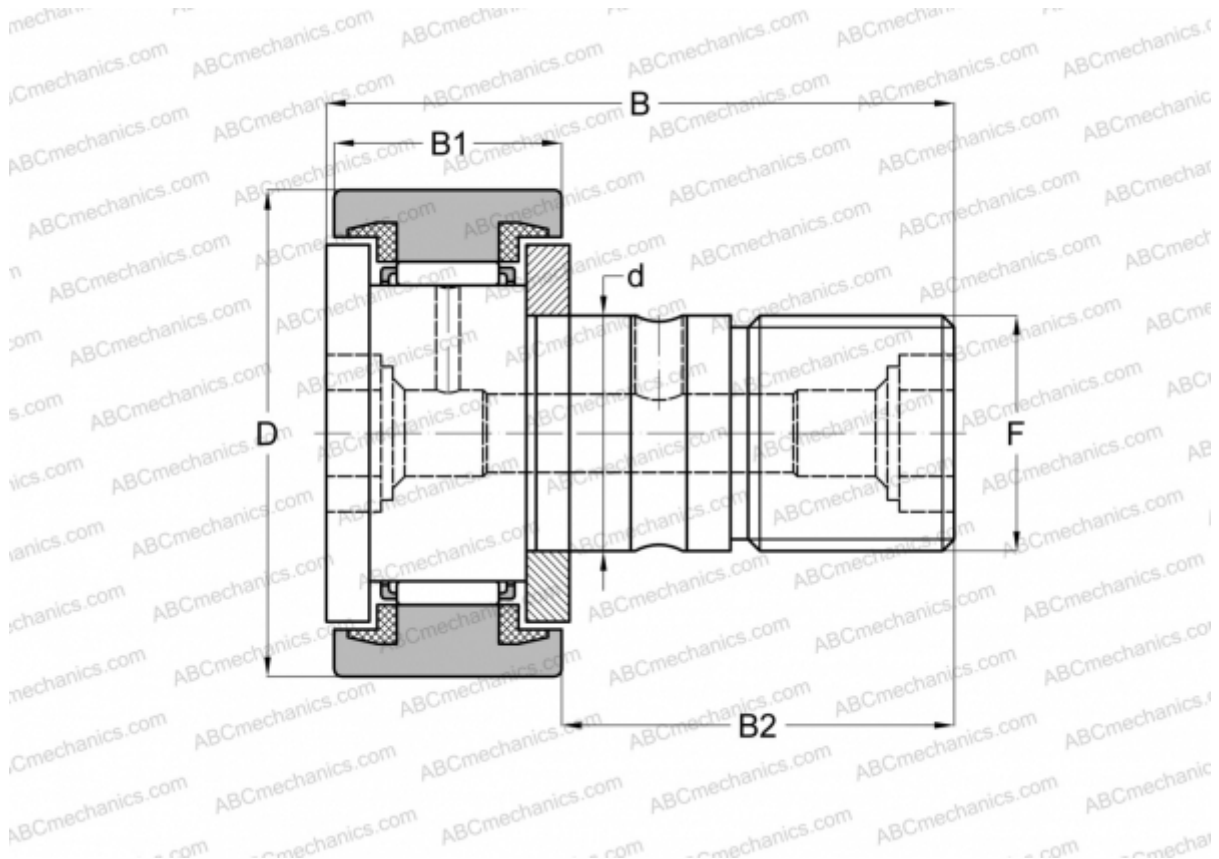

Technical specification

DIMENSIONS, MM

d	8,000
D	19,000
B	32,000
B1	11,000
B2	20,000
F	M8x1.25

WEIGHT, KG 0,032

MANUFACTURER [ABC](#)

INTERCHANGE

FAG	KR 19C DZ 2RS/ NAKD 19 DZ
INA	KR 19 PPX
SKF	KR 19 PPX
IKO	CF 8 UU

INTERCHANGE

McGill [MCFR-19-SX](#)