

MCFR-30-SX McGill

Cam followers

TYPE: Roller bearings, Stud type track rollers, With axial guidance, sealing rings on both sides, cylindrical outer ring

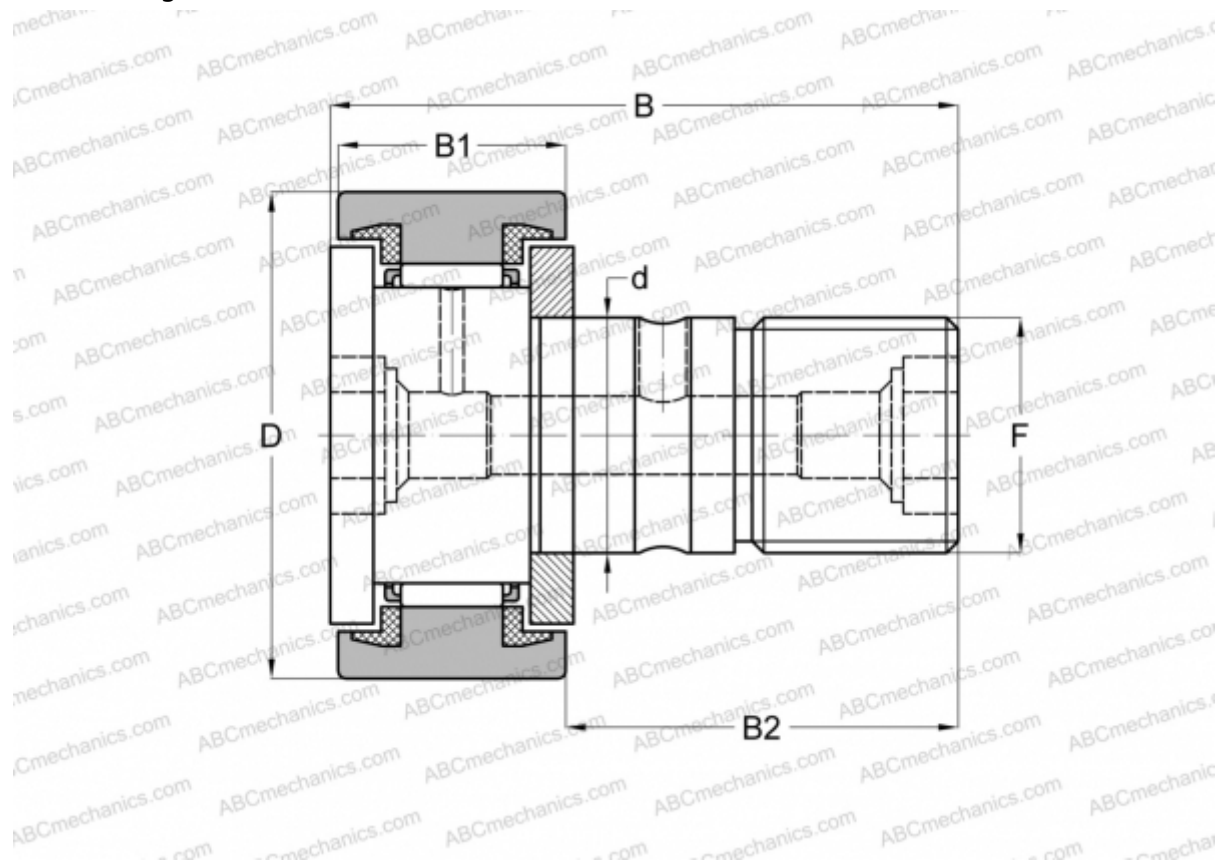

Technical specification

DIMENSIONS, MM

d	12,000
D	30,000
B	40,000
B1	14,000
B2	25,000
F	M12x1.5

WEIGHT, KG 0,091

MANUFACTURER [McGill](#)

INTERCHANGE

ABC	KR 30 PPX
FAG	KR 30C DZ 2RS/ NAKD 30 DZ
INA	KR 30 PPX
SKF	KR 30 PPX

INTERCHANGE

IKO [CF 12 UU](#)