

## MCFR-62-SX McGill

Cam followers

TYPE: Roller bearings, Stud type track rollers, With axial guidance, sealing rings on both sides, cylindrical outer ring

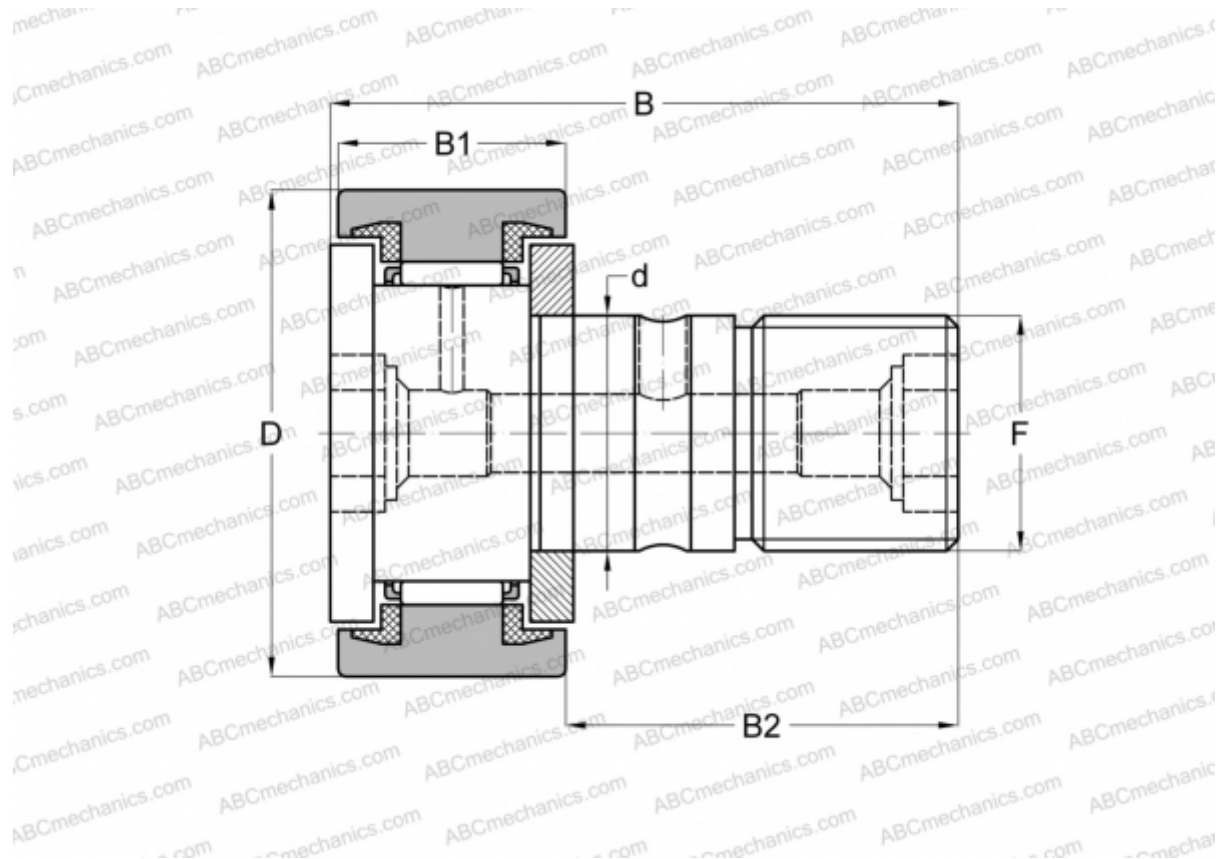

### Technical specification

#### DIMENSIONS, MM

d	24,000
D	62,000
B	80,000
B1	29,000
B2	49,500
F	M24x1.5

**WEIGHT, KG** 0,798

**MANUFACTURER** [McGill](#)

#### INTERCHANGE

ABC	<a href="#">KR 62 PPX</a>
INA	<a href="#">KR 62 PPX</a>
SKF	<a href="#">KR 62 PPX</a>
IKO	<a href="#">CF 24 UU</a>