

MCFR-72-SX McGill

Cam followers

TYPE: Roller bearings, Stud type track rollers, With axial guidance, sealing rings on both sides, cylindrical outer ring

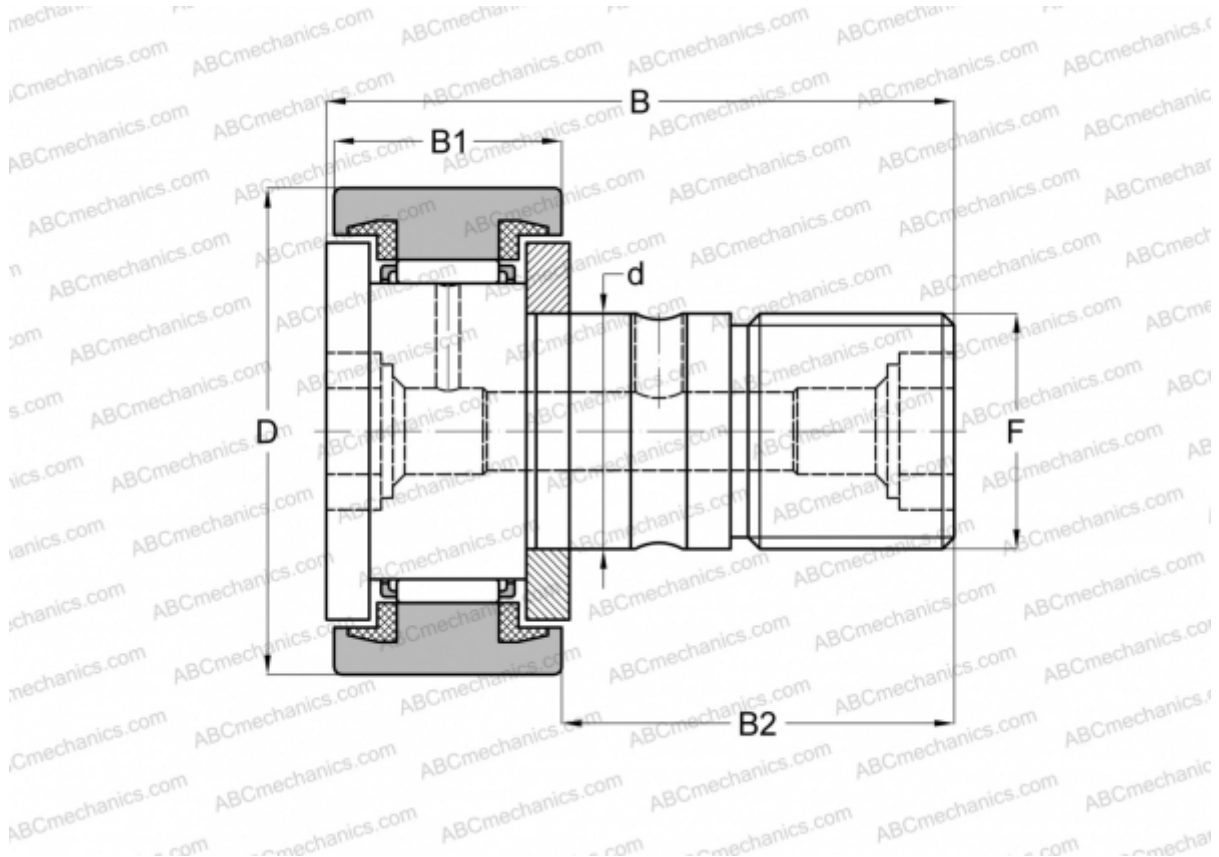

Technical specification

DIMENSIONS, MM

d	24,000
D	72,000
B	80,000
B1	29,000
B2	49,500
F	M24x1.5

WEIGHT, KG 1,038

MANUFACTURER [McGill](#)

INTERCHANGE

ABC	KR 72 PPX
INA	KR 72 PPX
SKF	KR 72 PPX
IKO	CF 24-1 UU