

CFKR 26 UUR ABC

Cam followers

TYPE: Roller bearings, Stud type track rollers, With axial guidance, sealing rings on both sides, double hex hole

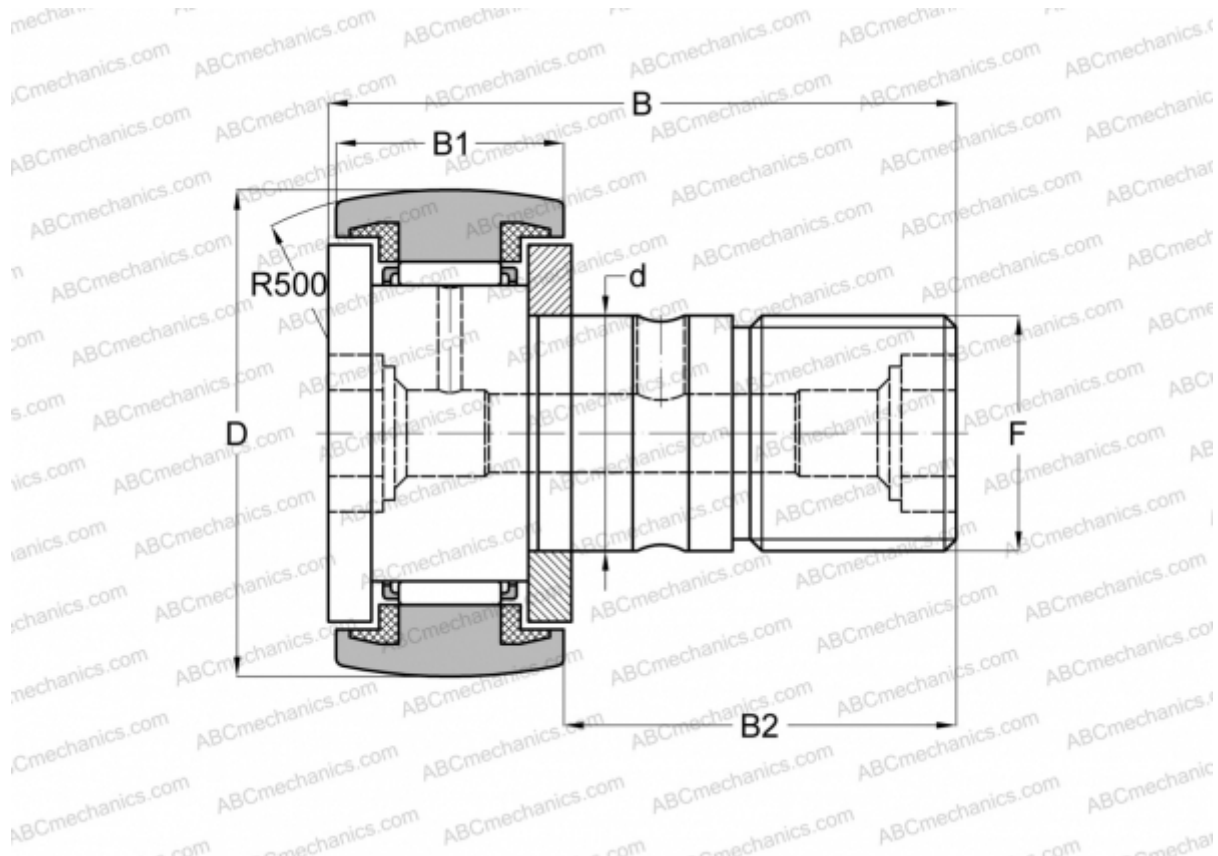

Technical specification

DIMENSIONS, MM

d	10,000
D	26,000
B	36,000
B1	12,000
B2	23,000
F	M10x1

WEIGHT, KG 0,059

MANUFACTURER [ABC](#)

INTERCHANGE

IKO [CFKR 26 UUR](#)