

CFKR 72 UUR ABC

Cam followers

TYPE: Roller bearings, Stud type track rollers, With axial guidance, sealing rings on both sides, double hex hole

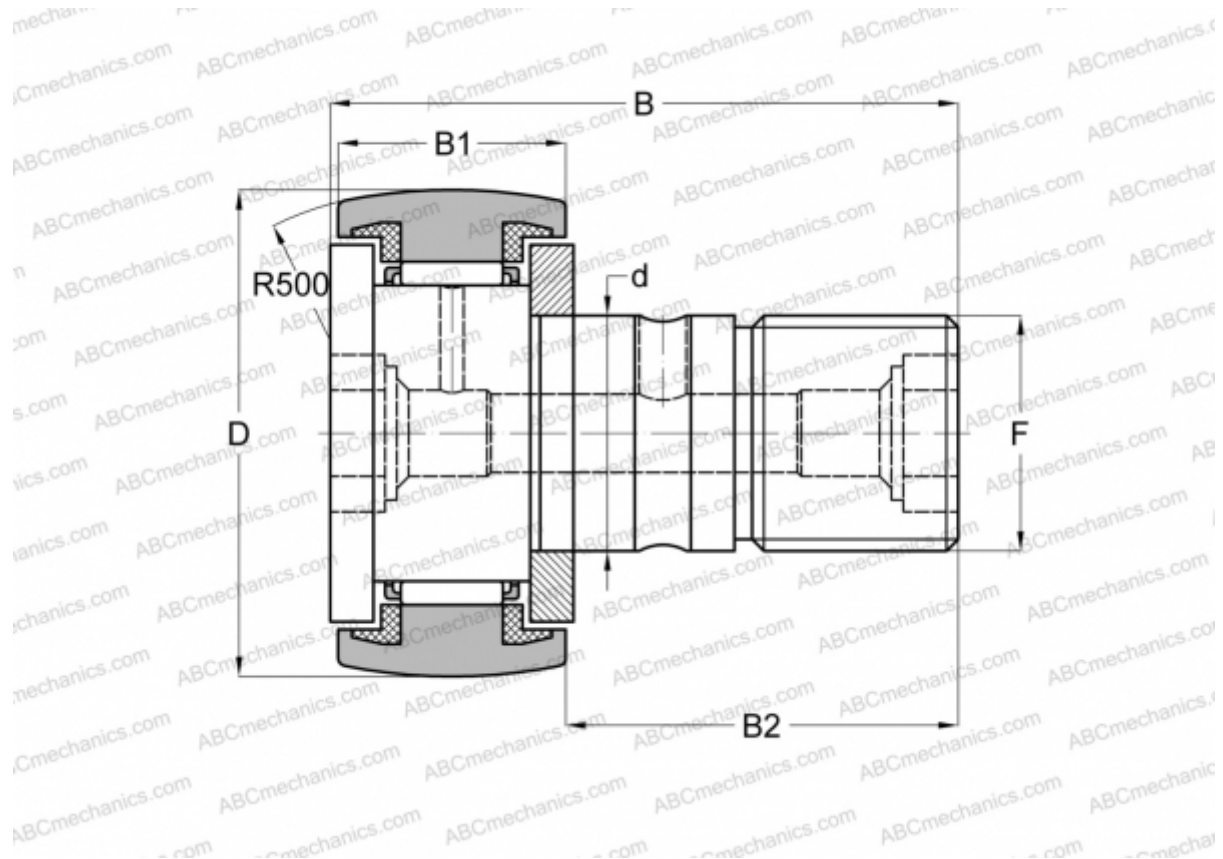

Technical specification

DIMENSIONS, MM

d	24,000
D	72,000
B	80,000
B1	29,000
B2	49,500
F	M24x1.5

WEIGHT, KG 1,038

MANUFACTURER [ABC](#)

INTERCHANGE

IKO	CFKR 72 UUR
JNS	CF 24-1 UUR-AB
THK	CF 24-1 UUR-AB