

CFKR 30 UU IKO

Cam followers

TYPE: Roller bearings, Stud type track rollers, With axial guidance, sealing rings on both sides, cylindrical outer ring, double hex hole

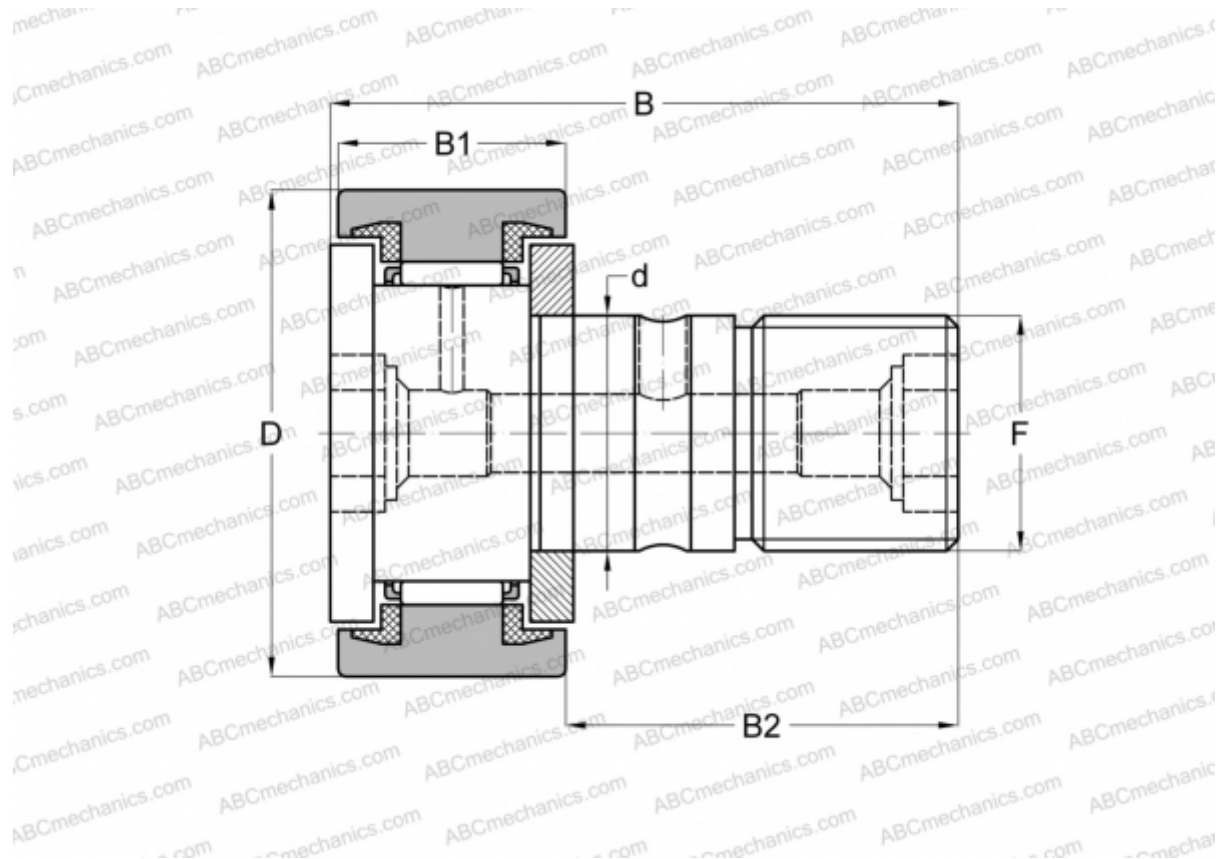

Technical specification

DIMENSIONS, MM

d	12,000
D	30,000
B	40,200
B1	14,000
B2	25,000
F	M12x1.5

WEIGHT, KG 0,094

MANUFACTURER [IKO](#)

INTERCHANGE

ABC	CFKR 30 UU
JNS	CF 12 UU-AB
THK	CF 12 UU-AB

CALCULATION DATA

Basic dynamic load rating, C	7,910 kN
Basic static load rating, Co	9,790 kN