

## CF 16 UU-AB THK

Cam followers

TYPE: Roller bearings, Stud type track rollers, With axial guidance, sealing rings on both sides, cylindrical outer ring, double hex hole

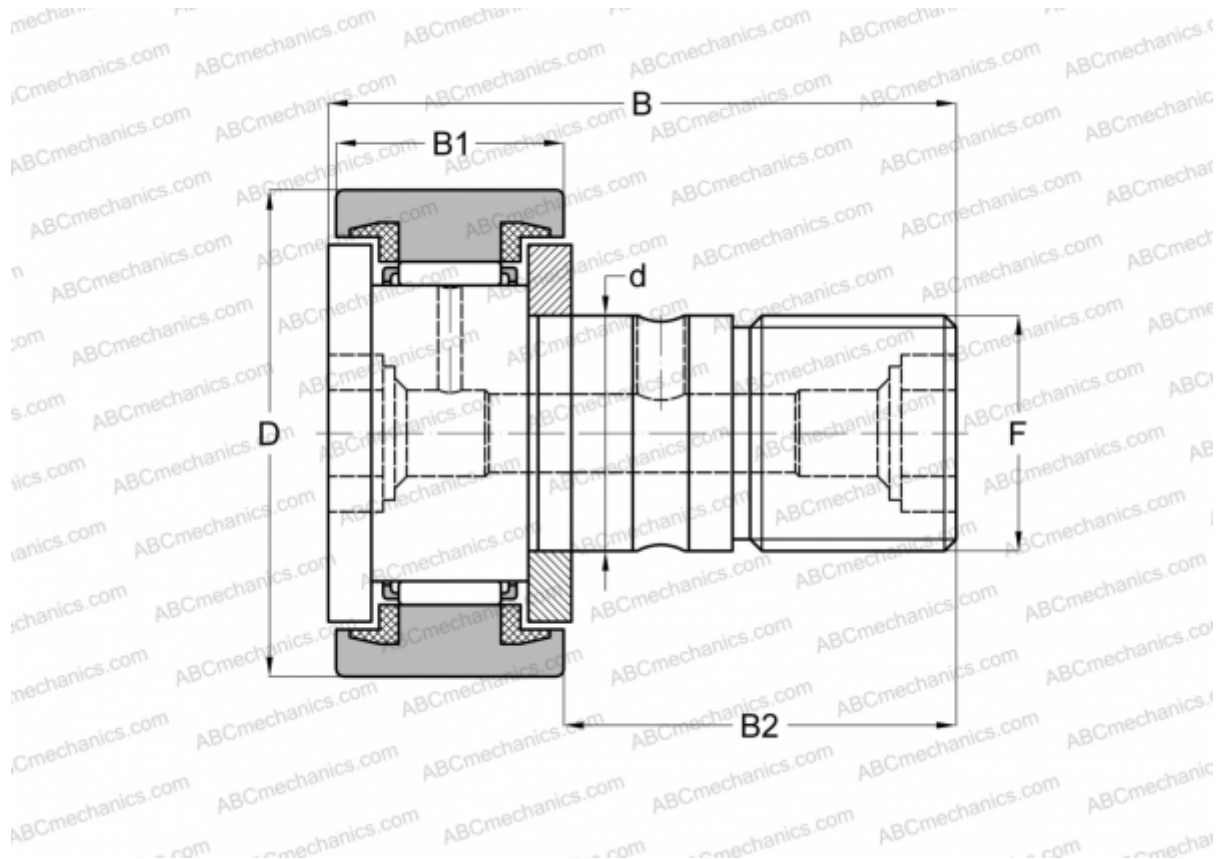

### Technical specification

#### DIMENSIONS, MM

d	16,000
D	35,000
B	52,000
B1	18,000
B2	32,500
F	M16x1.5

**WEIGHT, KG** 0,177

**MANUFACTURER** [THK](#)

#### INTERCHANGE

ABC	<a href="#">CFKR 35 UU</a>
IKO	<a href="#">CFKR 35 UU</a>
JNS	<a href="#">CF 16 UU-AB</a>