

CF 20-1 UU-AB THK

Cam followers

TYPE: Roller bearings, Stud type track rollers, With axial guidance, sealing rings on both sides, cylindrical outer ring, double hex hole

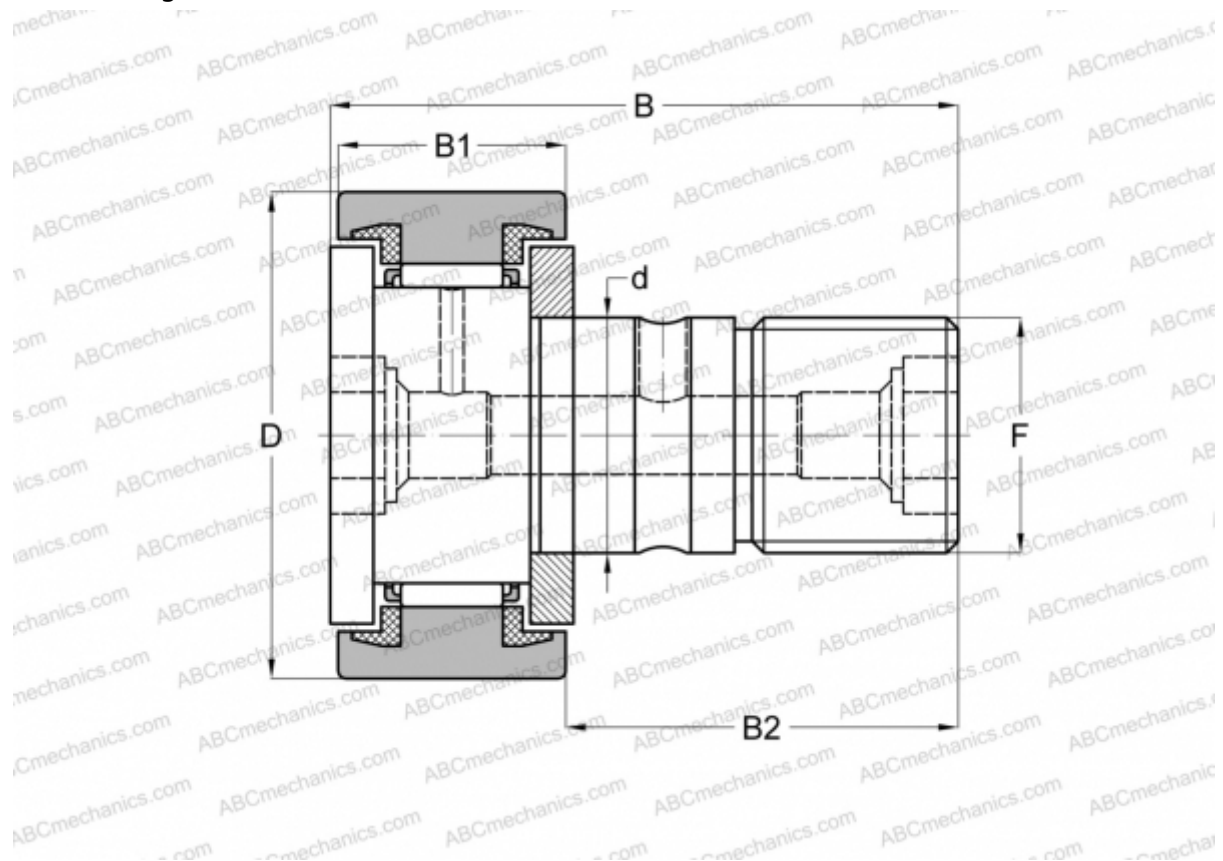

Technical specification

DIMENSIONS, MM

d	20,000
D	47,000
B	66,000
B1	24,000
B2	40,500
F	M20x1.5

WEIGHT, KG 0,400

MANUFACTURER [THK](#)

INTERCHANGE

ABC	CFKR 47 UU
IKO	CFKR 47 UU
JNS	CF 20-1 UU-AB