

CFKR 62 UU ABC

Cam followers

TYPE: Roller bearings, Stud type track rollers, With axial guidance, sealing rings on both sides, cylindrical outer ring, double hex hole

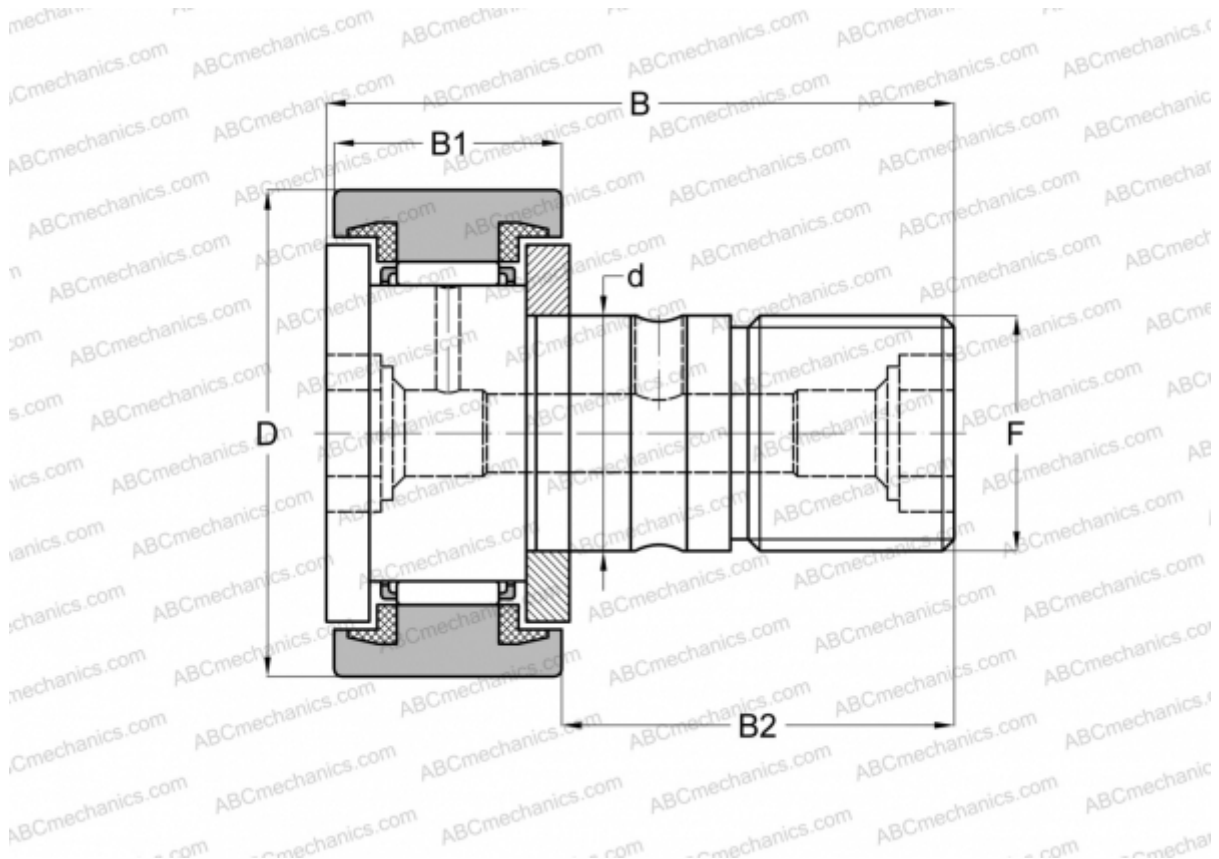

Technical specification

DIMENSIONS, MM

d	24,000
D	62,000
B	80,000
B1	29,000
B2	49,500
F	M24x1.5

WEIGHT, KG 0,798

MANUFACTURER [ABC](#)

INTERCHANGE

IKO	CFKR 62 UU
JNS	CF 24 UU-AB
THK	CF 24 UU-AB