

KR 40 SK SKF

Cam followers

TYPE: Roller bearings, Stud type track rollers, With axial guidance, gap seals on both side, hex hole

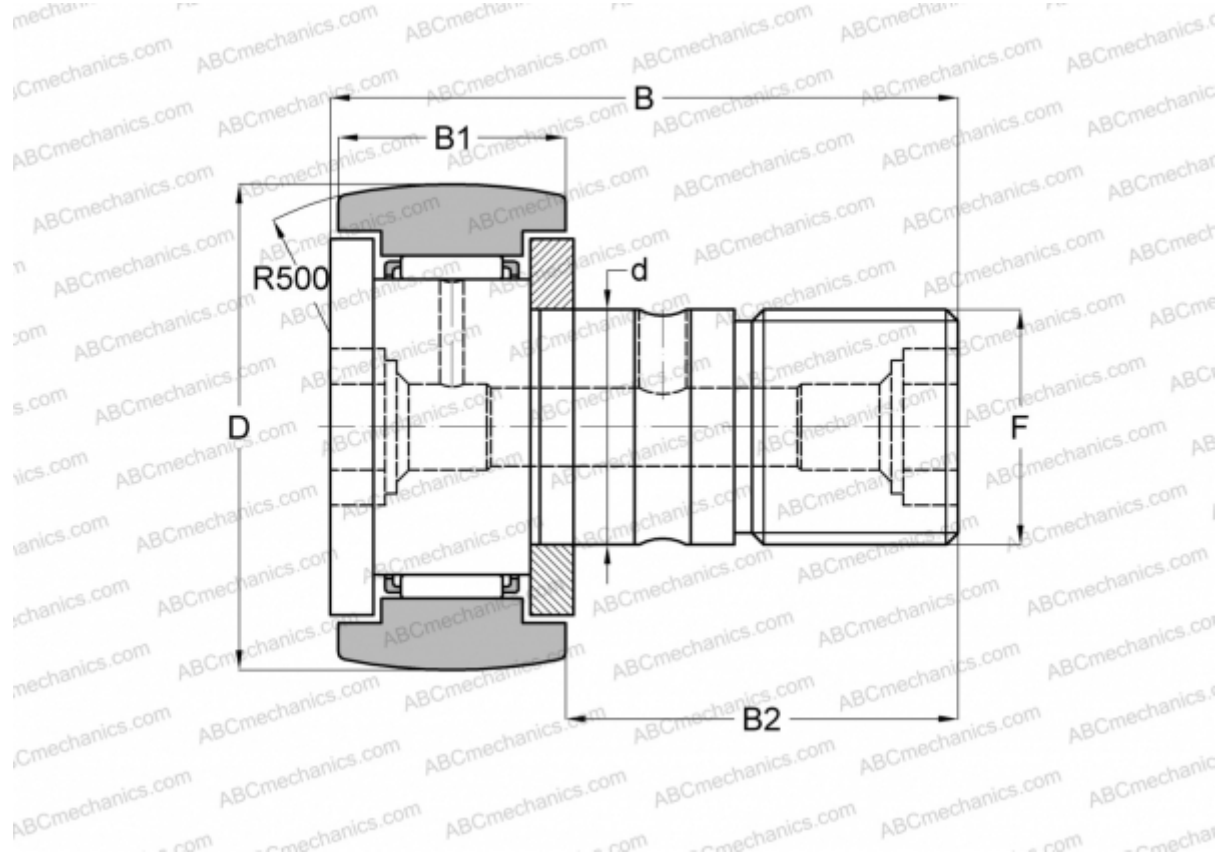

Technical specification

DIMENSIONS, MM

d	18,000
D	40,000
B	58,100
B1	20,000
B2	36,500
F	M18x1.5

WEIGHT, KG 0,250

MANUFACTURER [SKF](#)

INTERCHANGE

ABC	CF 18 BR
IKO	CF 18 BR
INA	KR 40 SK
McGill	MCFR-40-B