

KR 52 SK INA

Cam followers

TYPE: Roller bearings, Stud type track rollers, With axial guidance, gap seals on both side, hex hole

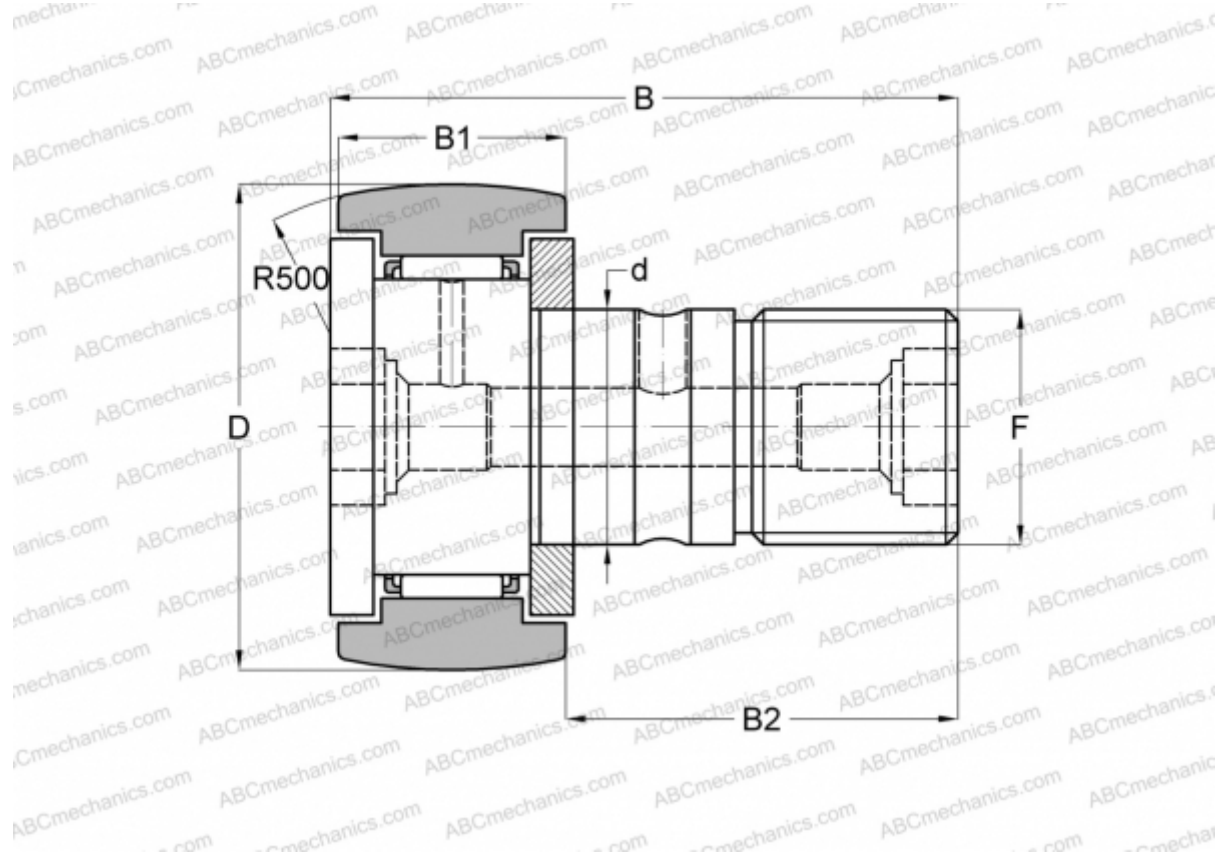

Technical specification

DIMENSIONS, MM

d	20,000
D	52,000
B	66,100
B1	24,000
B2	40,500
F	M20x1.5

WEIGHT, KG 0,460

MANUFACTURER [INA](#)

INTERCHANGE

ABC	CF 20 BR
IKO	CF 20 BR
SKF	KR 52 SK
McGill	MCFR-52-B