

## KR 52 SK SKF

Cam followers

TYPE: Roller bearings, Stud type track rollers, With axial guidance, gap seals on both side, hex hole

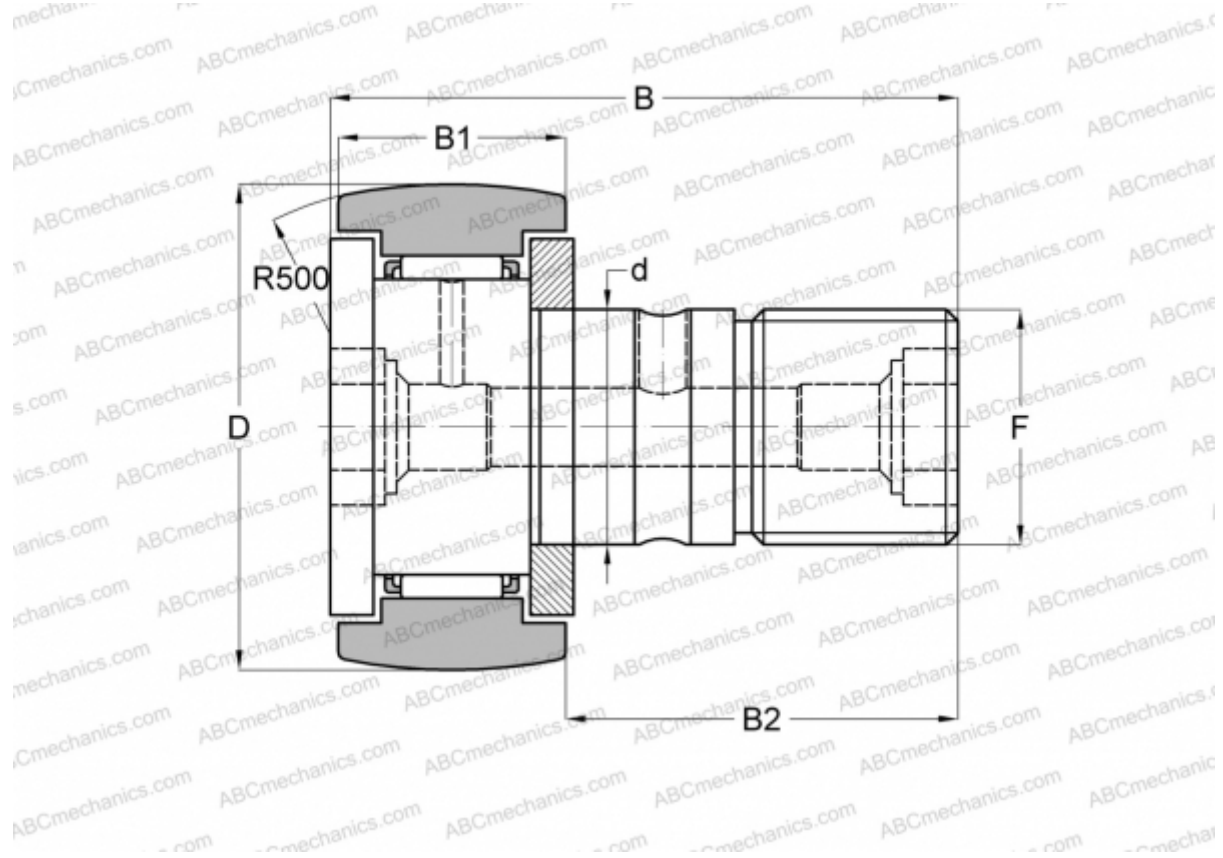

### Technical specification

#### DIMENSIONS, MM

d	20,000
D	52,000
B	66,100
B1	24,000
B2	40,500
F	M20x1.5

**WEIGHT, KG** 0,460

**MANUFACTURER** [SKF](#)

#### INTERCHANGE

ABC	<a href="#">CF 20 BR</a>
IKO	<a href="#">CF 20 BR</a>
INA	<a href="#">KR 52 SK</a>
McGill	<a href="#">MCFR-52-B</a>