

CF 12 BUUR ABC

Cam followers

TYPE: Roller bearings, Stud type track rollers, With axial guidance, sealing rings on both sides, hex socket

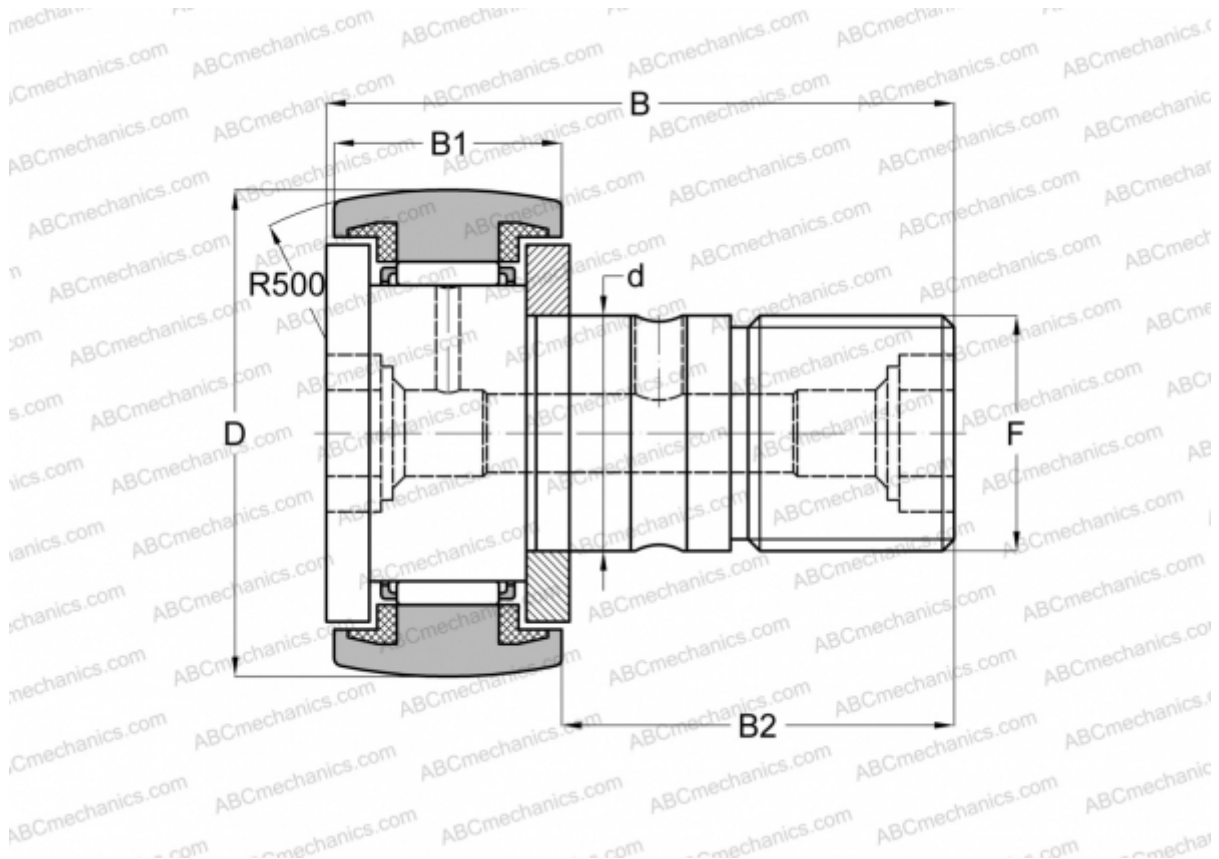

Technical specification

DIMENSIONS, MM

d	12,000
D	30,000
B	40,200
B1	14,000
B2	25,000
F	M12x1.5

WEIGHT, KG 0,095

MANUFACTURER [ABC](#)

INTERCHANGE

IKO	CF 12 BUUR
INA	KR 30 PPSK
SKF	KR 30 PPSK
McGill	MCFR-30-SB