

CF 12-1 BUUR IKO

Cam followers

TYPE: Roller bearings, Stud type track rollers, With axial guidance, sealing rings on both sides, hex socket

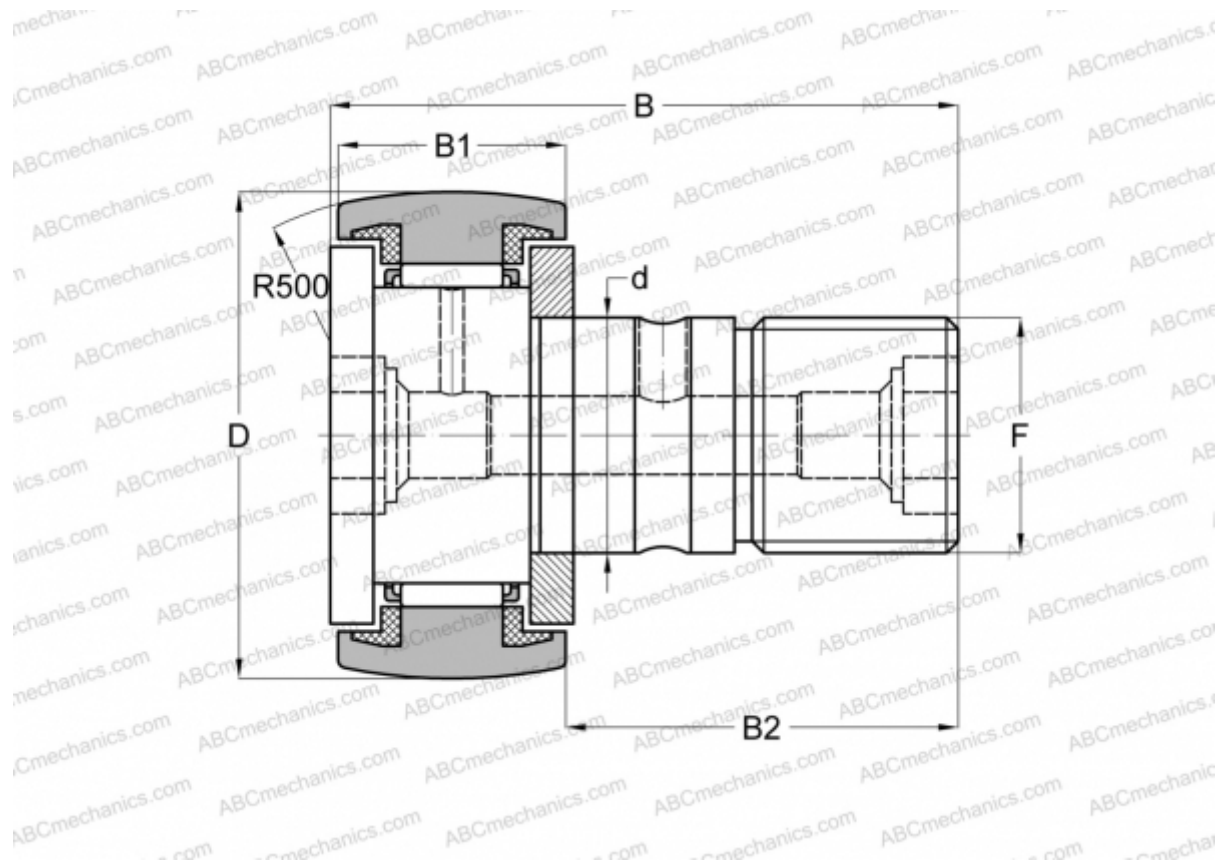

Technical specification

DIMENSIONS, MM

d	12,000
D	32,000
B	40,200
B1	14,000
B2	25,000
F	M12x1.5

WEIGHT, KG 0,105

MANUFACTURER [IKO](#)

INTERCHANGE

ABC	CF 12-1 BUUR
INA	KR 32 PPSK
SKF	KR 32 PPSK
McGill	MCFR-32-SB

CALCULATION DATA

Basic dynamic load rating, C	7,910 kN
Basic static load rating, Co	9,790 kN