

KR 40 PPSK SKF

Cam followers

TYPE: Roller bearings, Stud type track rollers, With axial guidance, sealing rings on both sides, hex socket

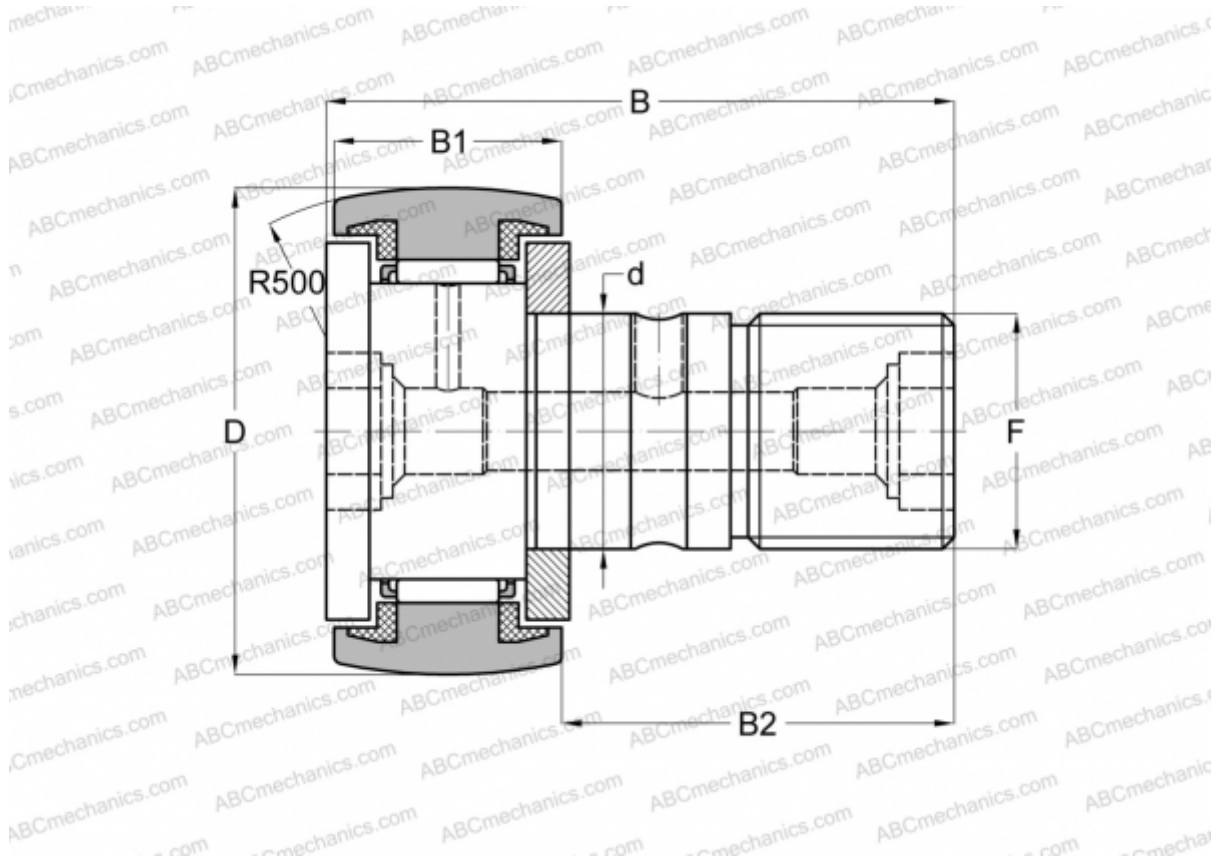

Technical specification

DIMENSIONS, MM

d	18,000
D	40,000
B	58,100
B1	20,000
B2	36,500
F	M18x1.5

WEIGHT, KG 0,250

MANUFACTURER [SKF](#)

INTERCHANGE

ABC	CF 18 BUUR
IKO	CF 18 BUUR
INA	KR 40 PPSK
McGill	MCFR-40-SB