

KR 52 PPSK INA

Cam followers

TYPE: Roller bearings, Stud type track rollers, With axial guidance, sealing rings on both sides, hex socket

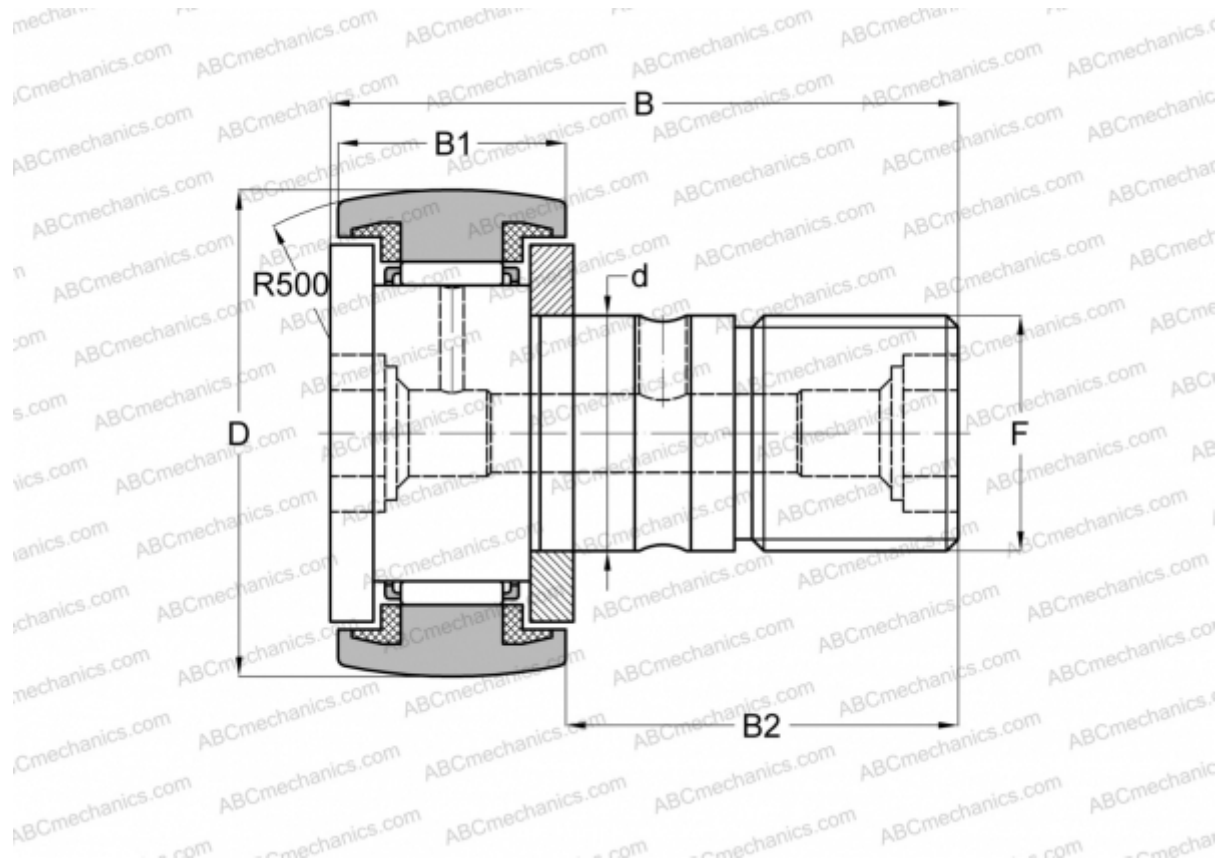

Technical specification

DIMENSIONS, MM

d	20,000
D	52,000
B	66,100
B1	24,000
B2	40,500
F	M20x1.5

WEIGHT, KG 0,460

MANUFACTURER [INA](#)

INTERCHANGE

ABC	CF 20 BUUR
IKO	CF 20 BUUR
SKF	KR 52 PPSK
McGill	MCFR-52-SB