

MCFR-72-SB McGill

Cam followers

TYPE: Roller bearings, Stud type track rollers, With axial guidance, sealing rings on both sides, hex socket

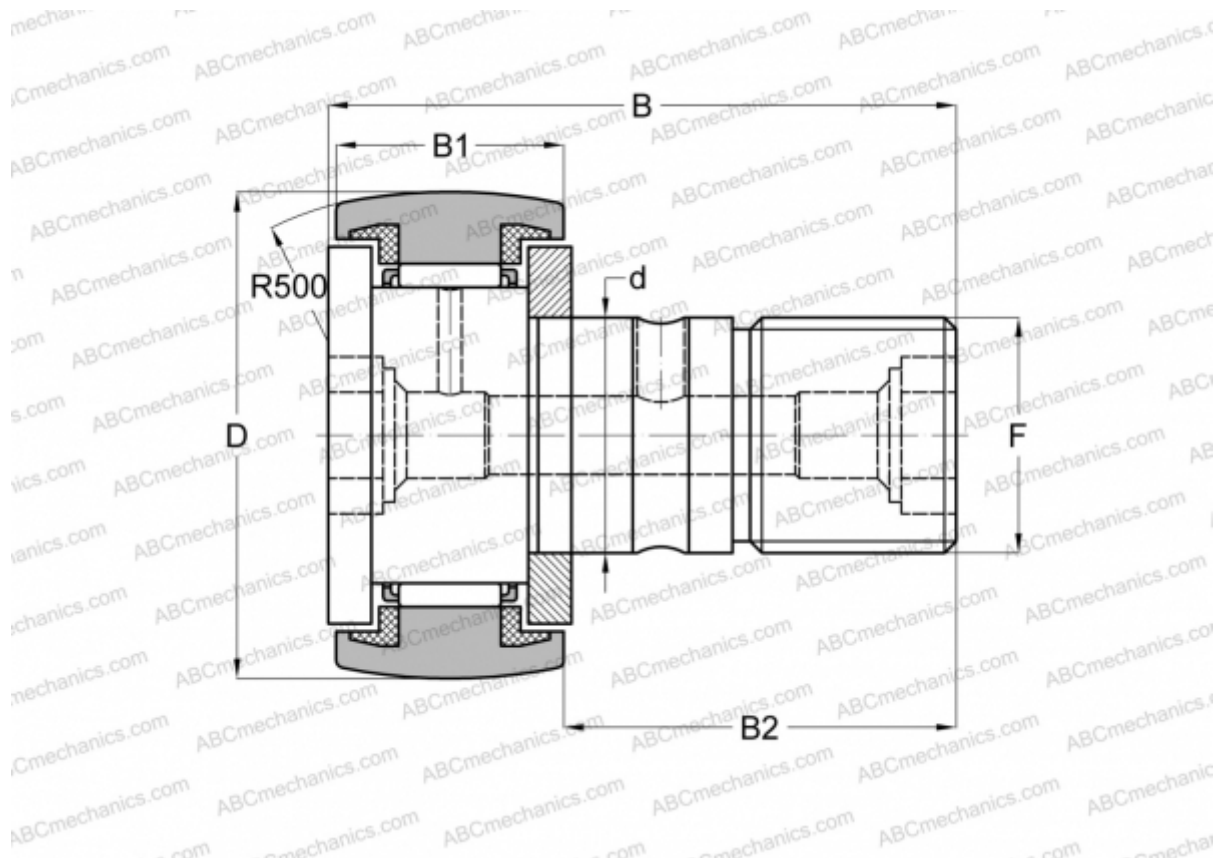

Technical specification

DIMENSIONS, MM

d	24,000
D	72,000
B	80,100
B1	29,000
B2	49,500
F	M24x1.5

WEIGHT, KG 1,140

MANUFACTURER [McGill](#)

INTERCHANGE

ABC	CF 24-1 BUUR
IKO	CF 24-1 BUUR
INA	KR 72 PP
SKF	KR 72 PP