

## MCFR-19-SB McGill

Cam followers

TYPE: Roller bearings, Stud type track rollers, With axial guidance, sealing rings on both sides, cylindrical outer ring, hex socket

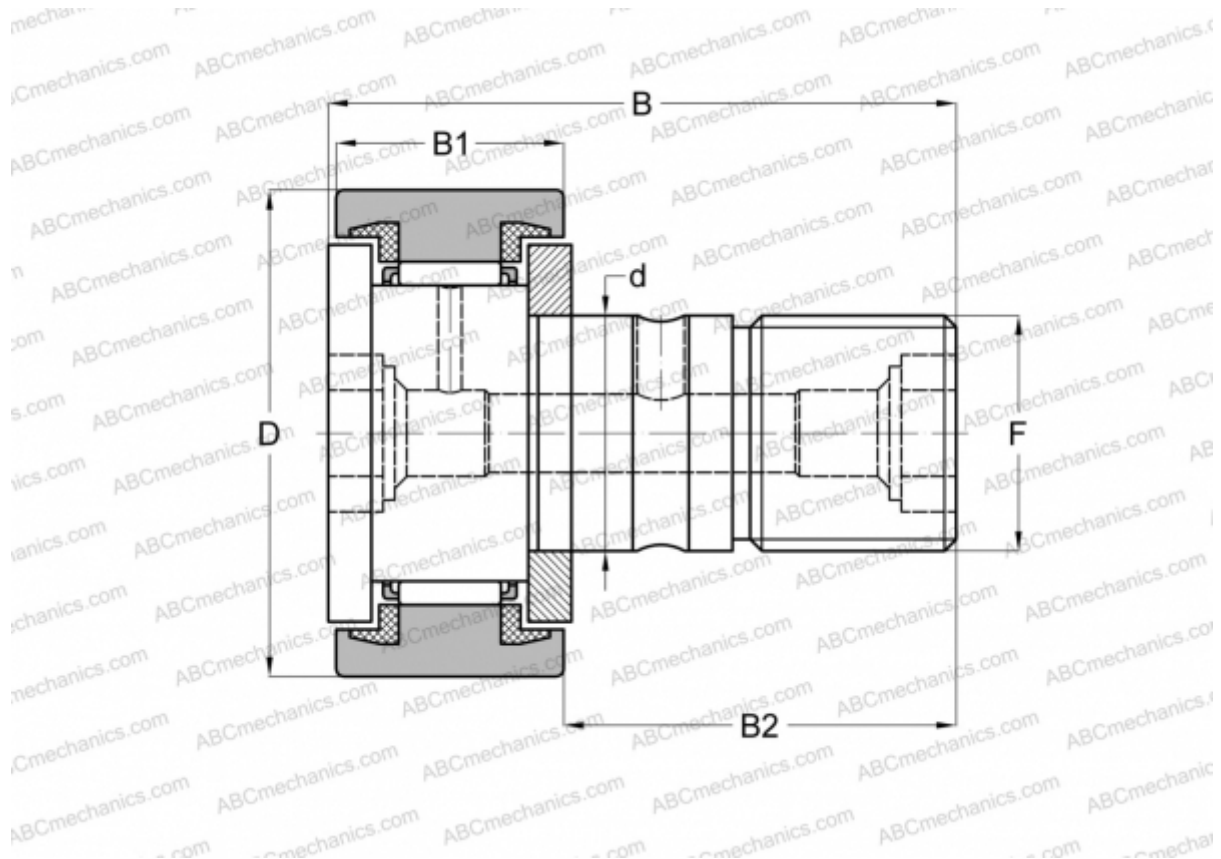

### Technical specification

#### DIMENSIONS, MM

d	8,000
D	19,000
B	32,200
B1	11,000
B2	20,000
F	M8x1.25

**WEIGHT, KG** 0,029

**MANUFACTURER** [McGill](#)

#### INTERCHANGE

ABC	<a href="#">CF 8 BUU</a>
IKO	<a href="#">CF 8 BUU</a>
INA	<a href="#">KR 19 PPXSK</a>
SKF	<a href="#">KR 19 PPXSK</a>