

CF 16 BUU ABC

Cam followers

TYPE: Roller bearings, Stud type track rollers, With axial guidance, sealing rings on both sides, cylindrical outer ring, hex socket

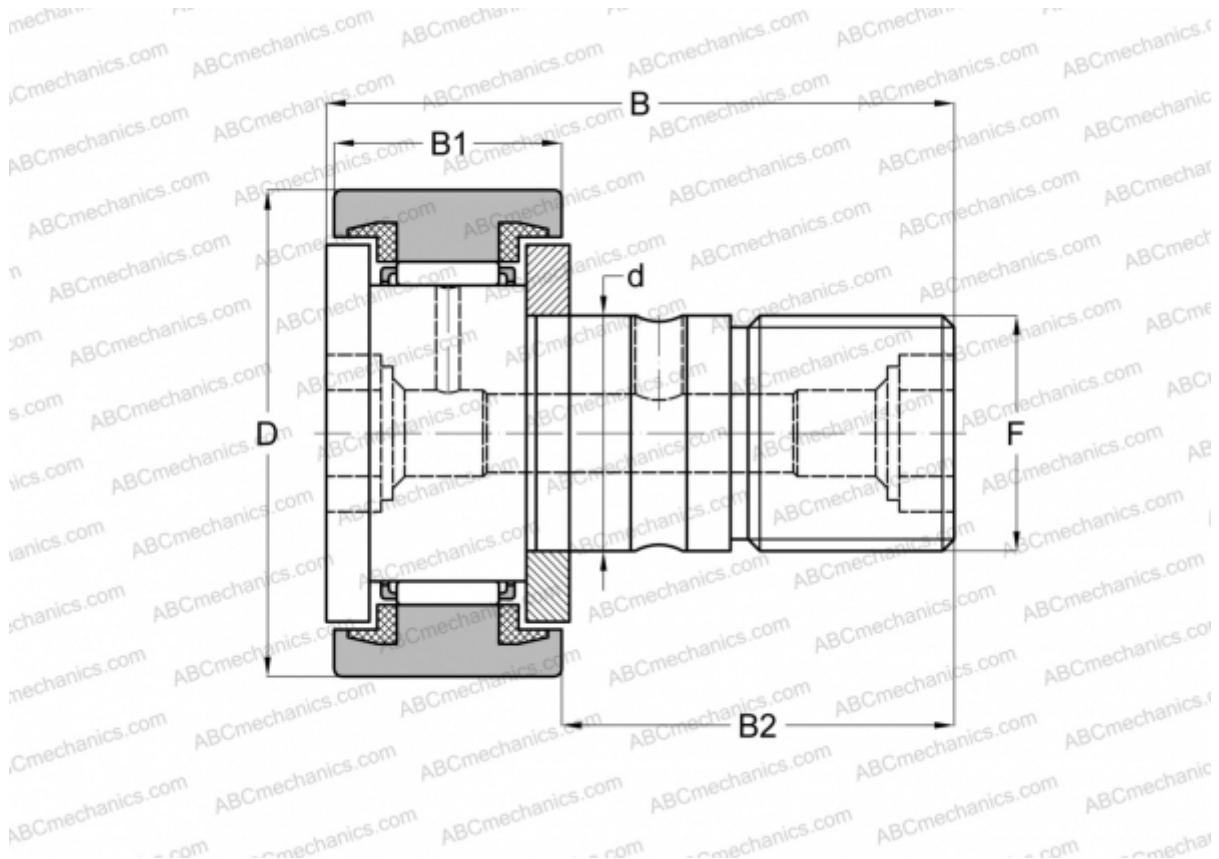

Technical specification

DIMENSIONS, MM

d	16,000
D	35,000
B	52,100
B1	18,000
B2	32,500
F	M16x1.5

WEIGHT, KG 0,170

MANUFACTURER [ABC](#)

INTERCHANGE

IKO	CF 16 BUU
INA	KR 35 PPXSK
SKF	KR 35 PPXSK
McGill	MCFR-35-SB