

## KR 40 PPXSK INA

Cam followers

TYPE: Roller bearings, Stud type track rollers, With axial guidance, sealing rings on both sides, cylindrical outer ring, hex socket

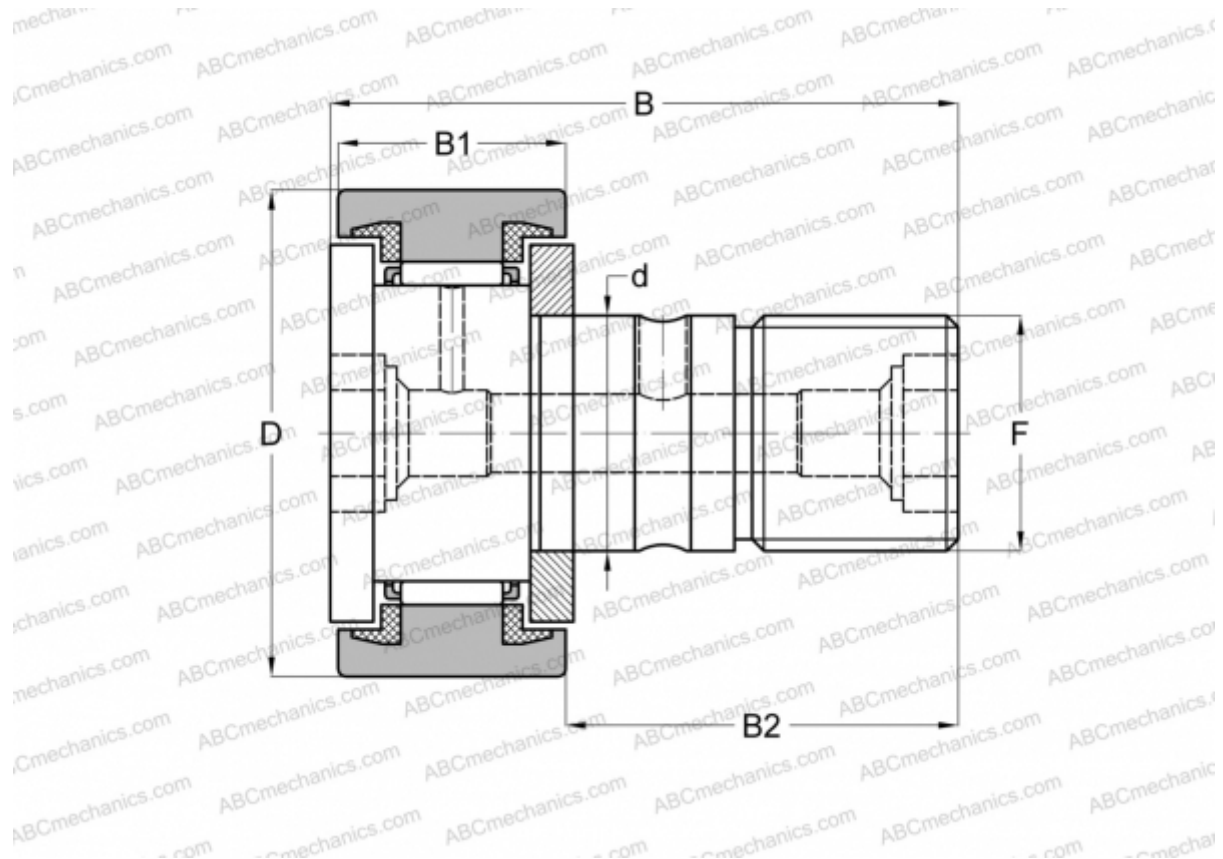

### Technical specification

#### DIMENSIONS, MM

d	18,000
D	40,000
B	58,100
B1	20,000
B2	36,500
F	M18x1.5

**WEIGHT, KG** 0,250

**MANUFACTURER** [INA](#)

#### INTERCHANGE

ABC	<a href="#">CF 18 BUU</a>
IKO	<a href="#">CF 18 BUU</a>
SKF	<a href="#">KR 40 PPXSK</a>
McGill	<a href="#">MCFR-40-SB</a>