

KR 62 PPX INA

Cam followers

TYPE: Roller bearings, Stud type track rollers, With axial guidance, sealing rings on both sides, cylindrical outer ring, hex socket

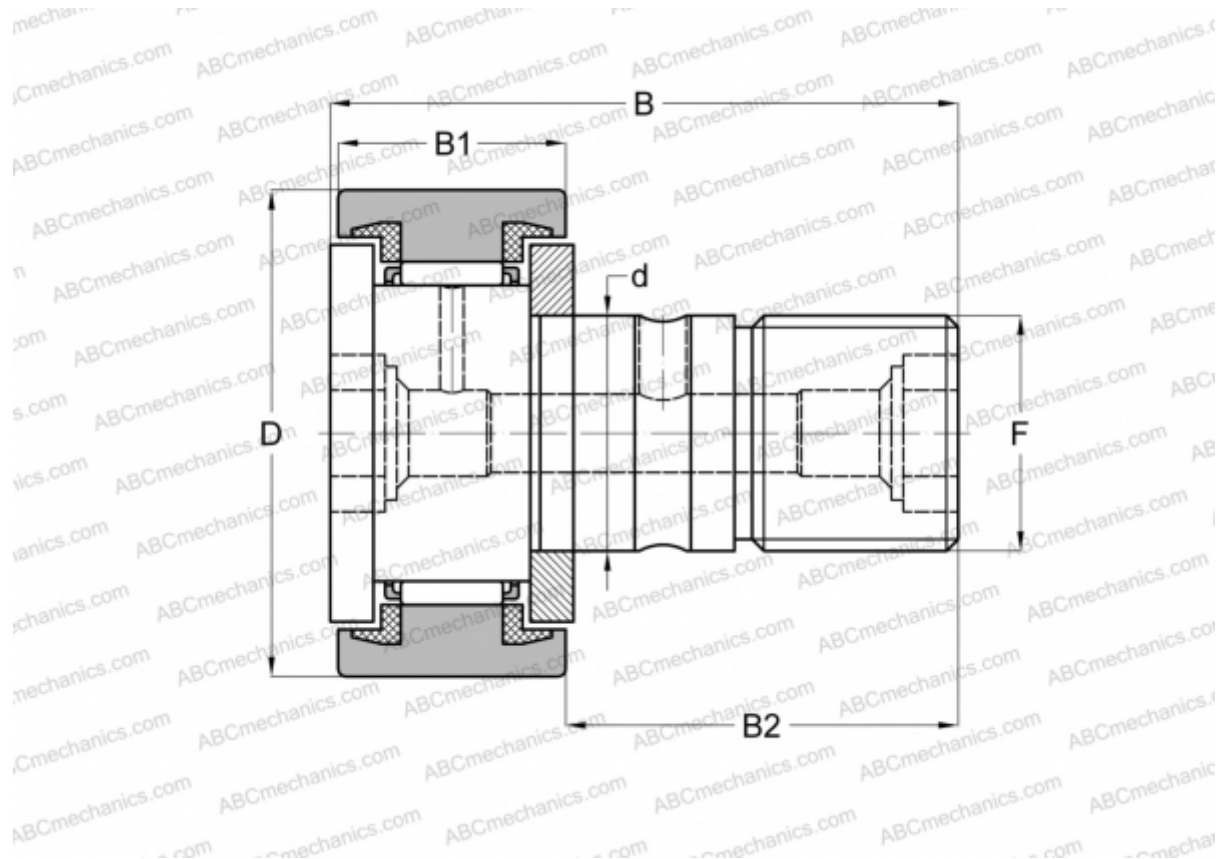

Technical specification

DIMENSIONS, MM

d	24,000
D	62,000
B	80,100
B1	29,000
B2	49,500
F	M24x1.5

WEIGHT, KG 0,815

MANUFACTURER [INA](#)

INTERCHANGE

ABC	CF 24 BUU
IKO	CF 24 BUU
SKF	KR 62 PPX
McGill	MCFR-62-SB