

KRV 19 X ABC

Cam followers

TYPE: Roller bearings, Stud type track rollers, With axial guidance, full complement bearing, gap seal on both side, cylindrical outer ring

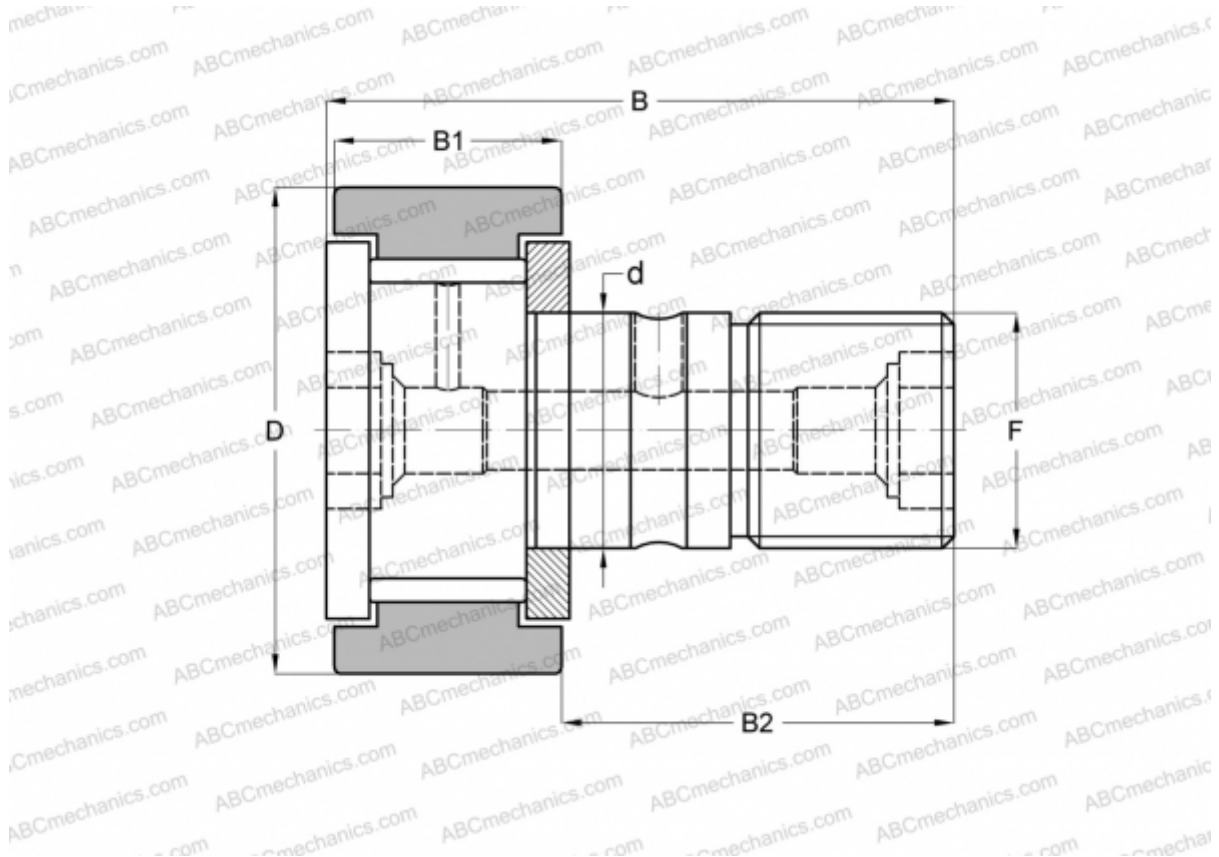

Technical specification

DIMENSIONS, MM

d	8,000
D	19,000
B	32,000
B1	11,000
B2	20,000
F	M8x1.25

WEIGHT, KG 0,032

MANUFACTURER [ABC](#)

INTERCHANGE

INA	KRV 19 X
SKF	KRV 19 X
IKO	CF 8 V
McGill	MCF-19-X