

MCF-32-X McGill

Cam followers

TYPE: Roller bearings, Stud type track rollers, With axial guidance, full complement bearing, gap seal on both side, cylindrical outer ring

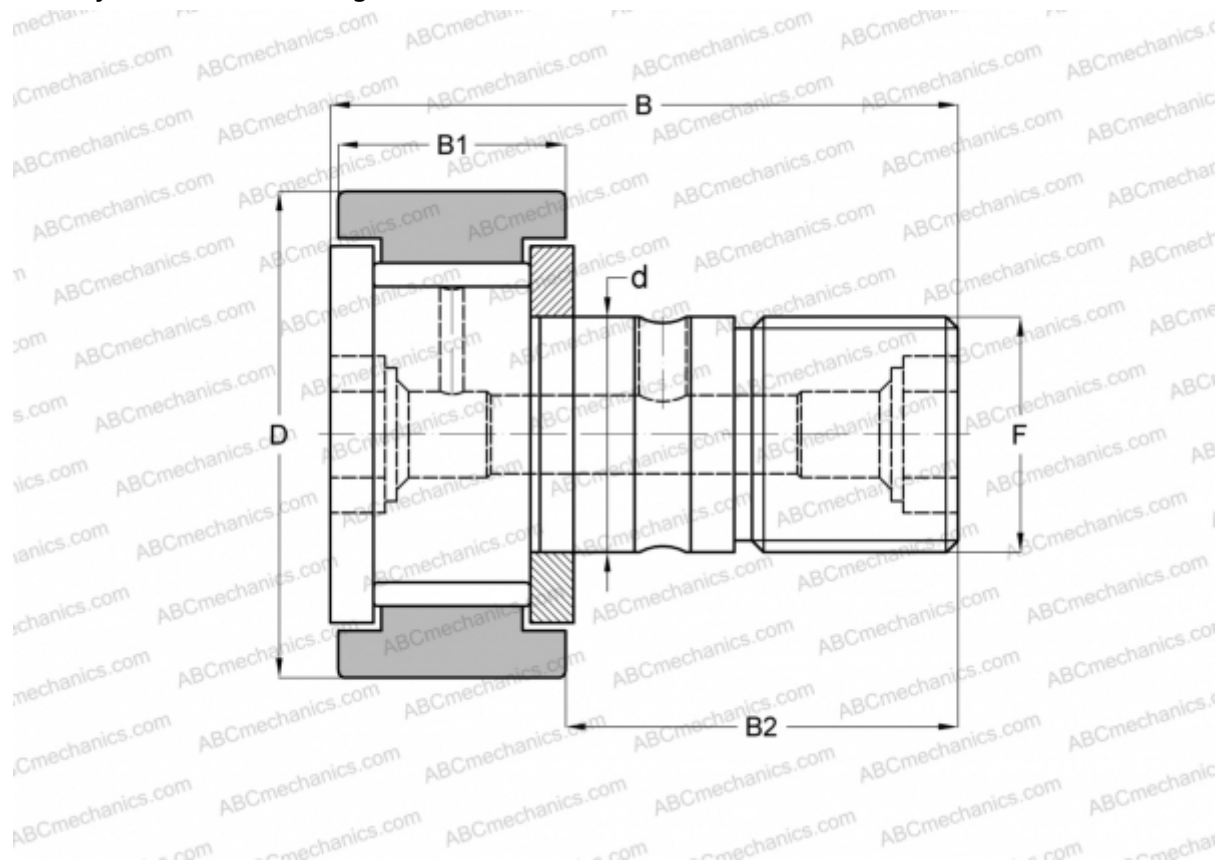

Technical specification

DIMENSIONS, MM

d	12,000
D	32,000
B	40,000
B1	14,000
B2	25,000
F	M12x1.5

WEIGHT, KG 0,100

MANUFACTURER [McGill](#)

INTERCHANGE

ABC	KRV 32 X
INA	KRV 32 X
SKF	KRV 32 X
IKO	CF 12-1 V