

MCF-40-X McGill

Cam followers

TYPE: Roller bearings, Stud type track rollers, With axial guidance, full complement bearing, gap seal on both side, cylindrical outer ring

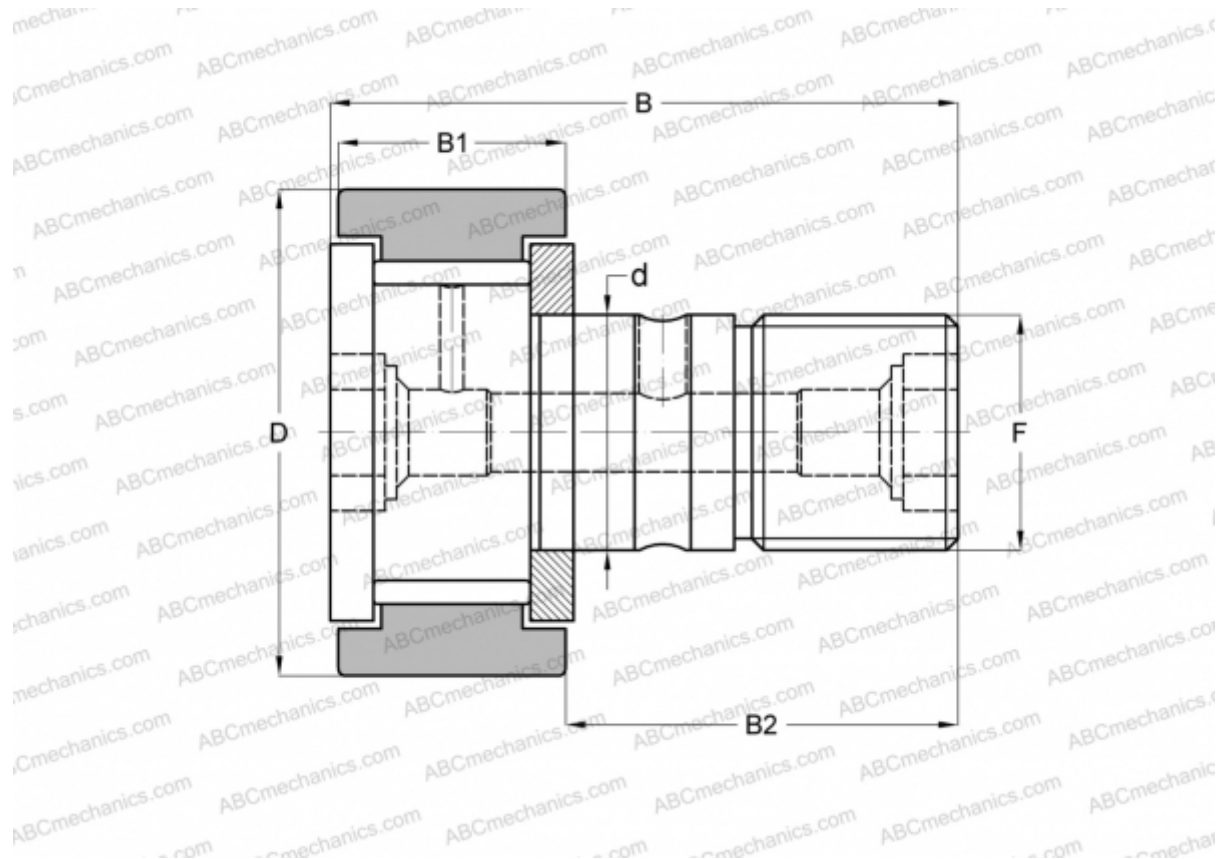

Technical specification

DIMENSIONS, MM

d	18,000
D	40,000
B	58,000
B1	20,000
B2	36,500
F	M18x1.5

WEIGHT, KG 0,255

MANUFACTURER [McGill](#)

INTERCHANGE

ABC	KRV 40 X
INA	KRV 40 X
SKF	KRV 40 X
IKO	CF 18 V