

## CF 20-1 V IKO

Cam followers

TYPE: Roller bearings, Stud type track rollers, With axial guidance, full complement bearing, gap seal on both side, cylindrical outer ring

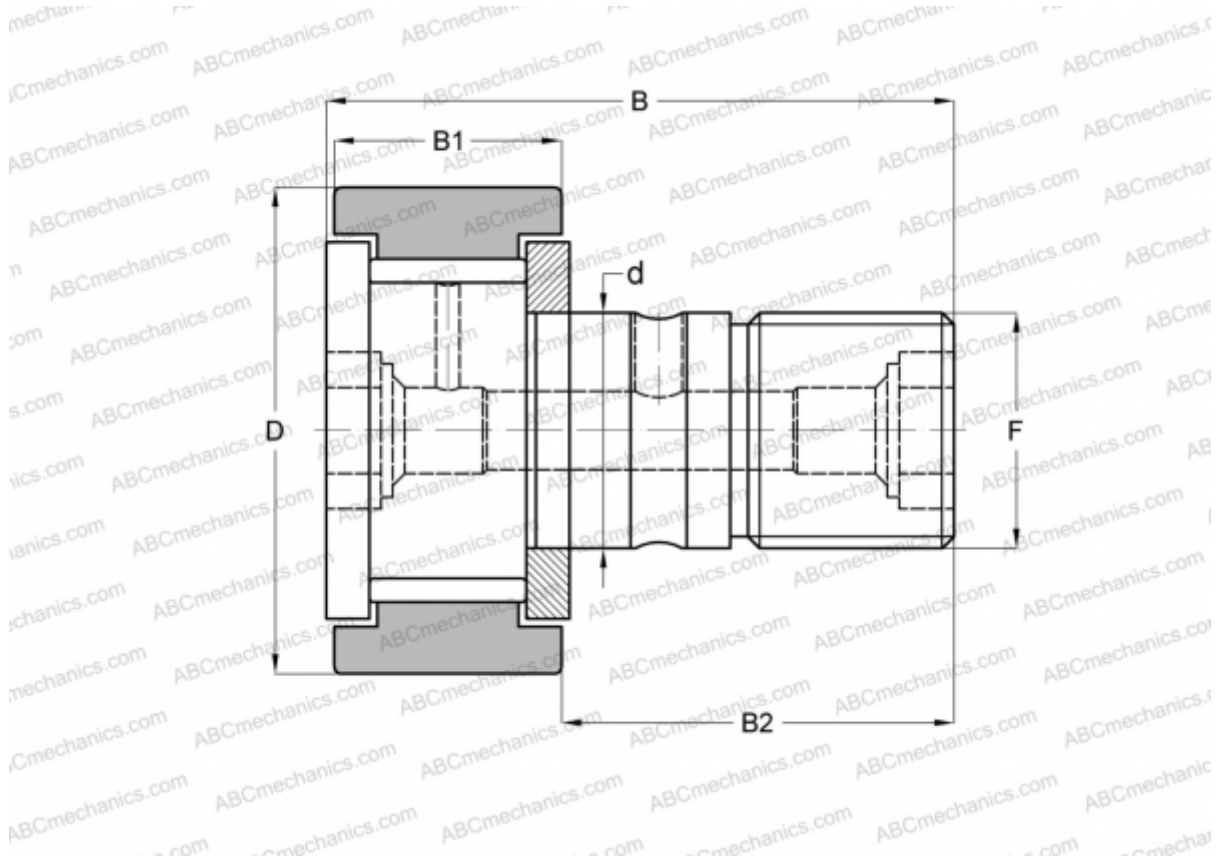

### Technical specification

#### DIMENSIONS, MM

d	20,000
D	47,000
B	66,100
B1	24,000
B2	40,500
F	M20x1.5

**WEIGHT, KG** 0,390

**MANUFACTURER** [IKO](#)

#### INTERCHANGE

ABC	<a href="#">KRV 47 X</a>
INA	<a href="#">KRV 47 X</a>
SKF	<a href="#">KRV 47 X</a>
McGill	<a href="#">MCF-47-X</a>

#### CALCULATION DATA

Basic dynamic load rating, C	33,200 kN
Basic static load rating, Co	64,500 kN