

MCF-52-X McGill

Cam followers

TYPE: Roller bearings, Stud type track rollers, With axial guidance, full complement bearing, gap seal on both side, cylindrical outer ring

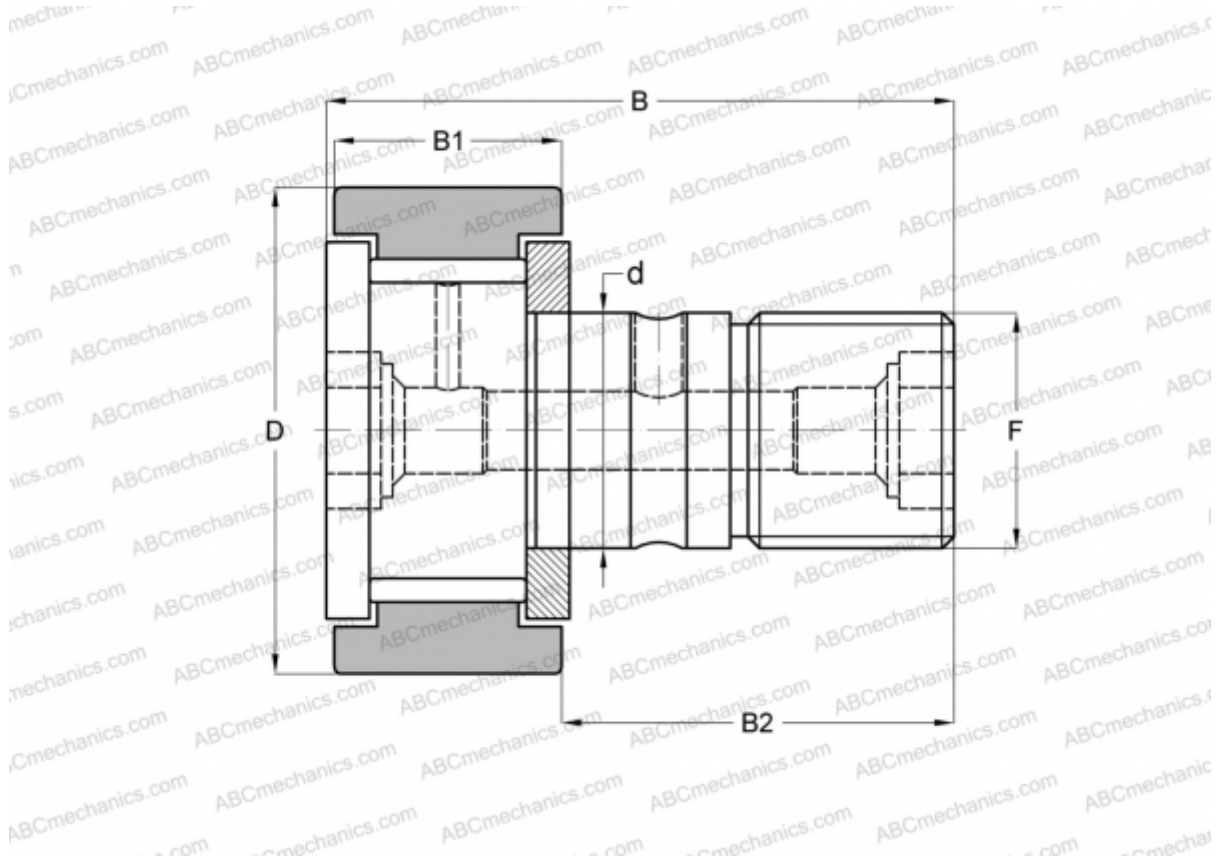

Technical specification

DIMENSIONS, MM

d	20,000
D	52,000
B	66,000
B1	24,000
B2	40,500
F	M20x1.5

WEIGHT, KG 0,473

MANUFACTURER [McGill](#)

INTERCHANGE

ABC	KRV 52 X
INA	KRV 52 X
SKF	KRV 52 X
IKO	CF 20 V