

CF 24 V IKO

Cam followers

TYPE: Roller bearings, Stud type track rollers, With axial guidance, full complement bearing, gap seal on both side, cylindrical outer ring

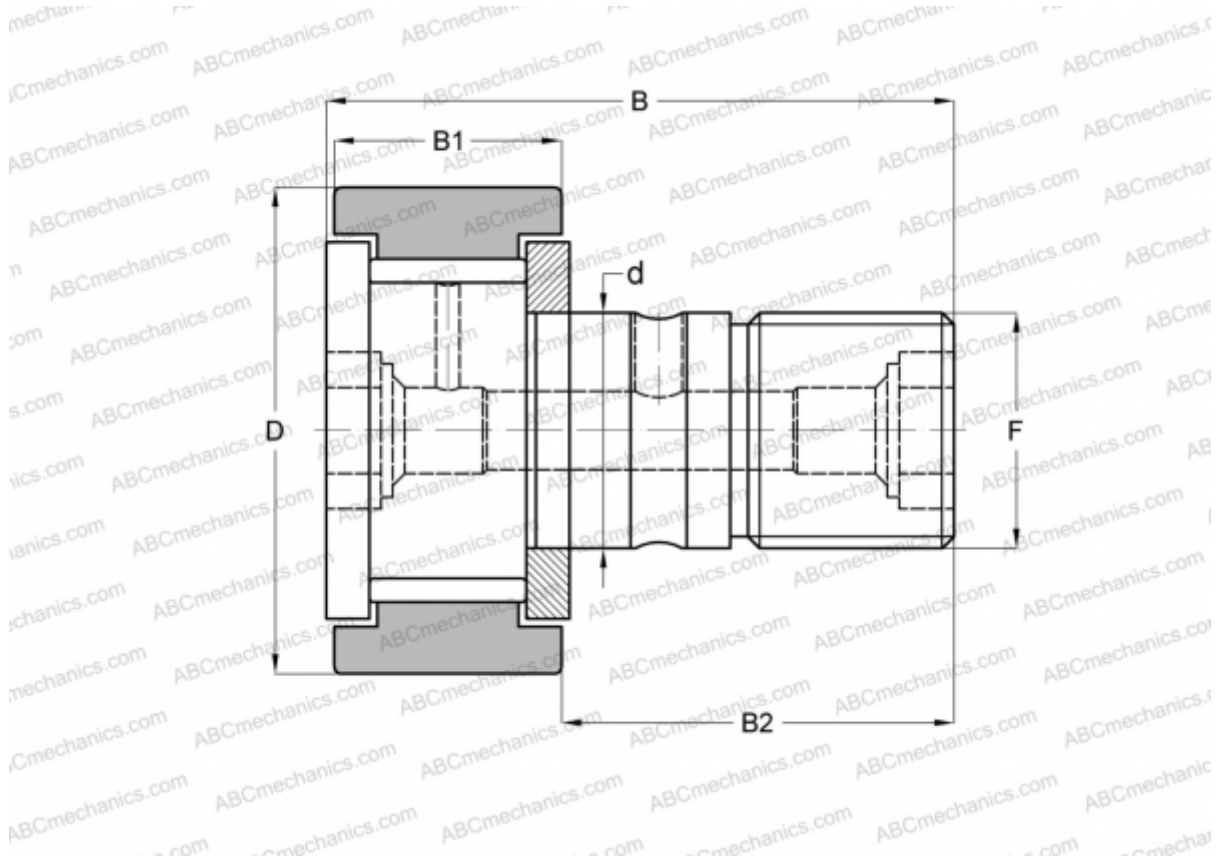

Technical specification

DIMENSIONS, MM

d	24,000
D	62,000
B	80,100
B1	29,000
B2	49,500
F	M24x1.5

WEIGHT, KG 0,820

MANUFACTURER [IKO](#)

INTERCHANGE

ABC	KRV 62 X
INA	KRV 62 X
SKF	KRV 62 X
McGill	MCF-62-X

CALCULATION DATA

Basic dynamic load rating, C	46,600 kN
Basic static load rating, Co	92,000 kN