

CFKR 30 V IKO

Cam followers

TYPE: Roller bearings, Stud type track rollers, With axial guidance, full complement bearing, gap seal on both side, cylindrical outer ring, double hex hole

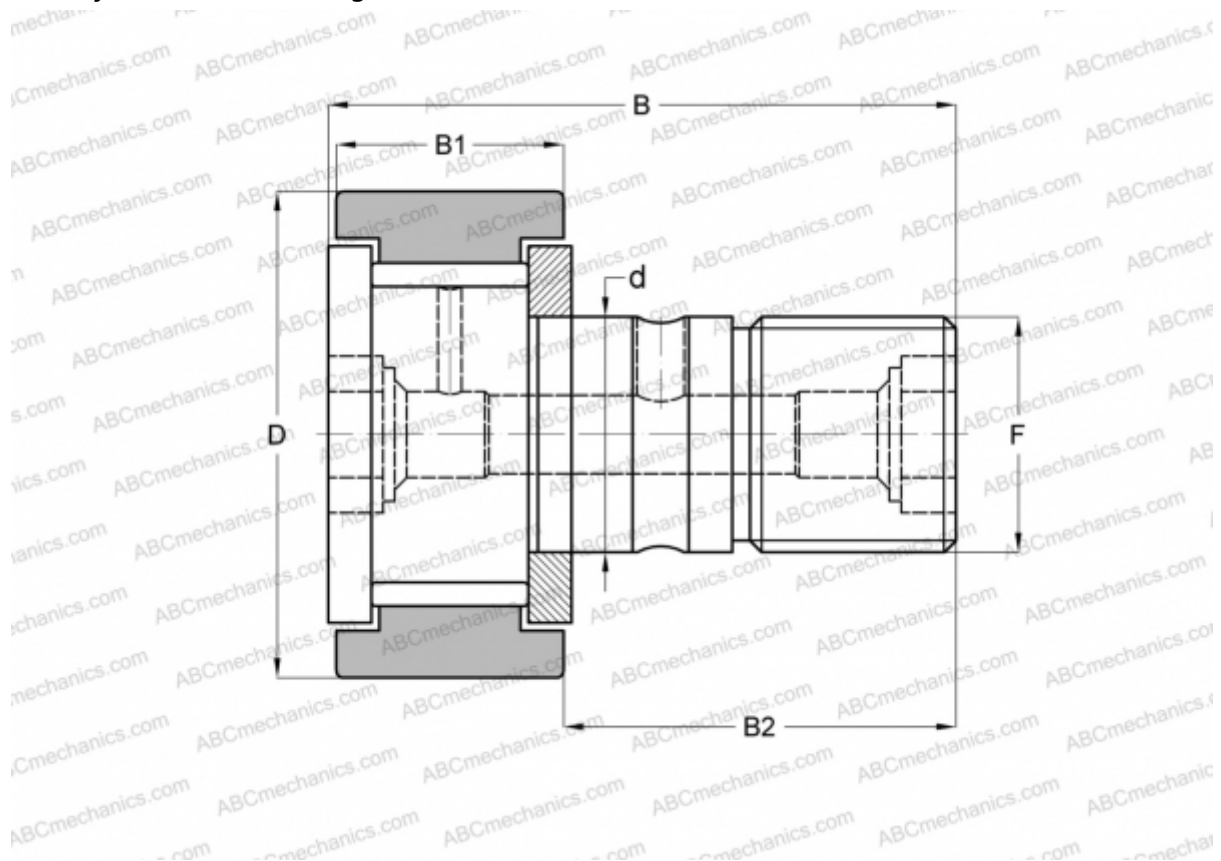

Technical specification

DIMENSIONS, MM

d	12,000
D	30,000
B	40,200
B1	14,000
B2	25,000
F	M12x1.5

WEIGHT, KG 0,096

MANUFACTURER [IKO](#)

INTERCHANGE

ABC	CFKR 30 V
JNS	CF 12 V-AB
THK	CF 12 V-AB

CALCULATION DATA

Basic dynamic load rating, C	13,500 kN
Basic static load rating, Co	19,700 kN