

## CFKR 40 V IKO

Cam followers

TYPE: Roller bearings, Stud type track rollers, With axial guidance, full complement bearing, gap seal on both side, cylindrical outer ring, double hex hole

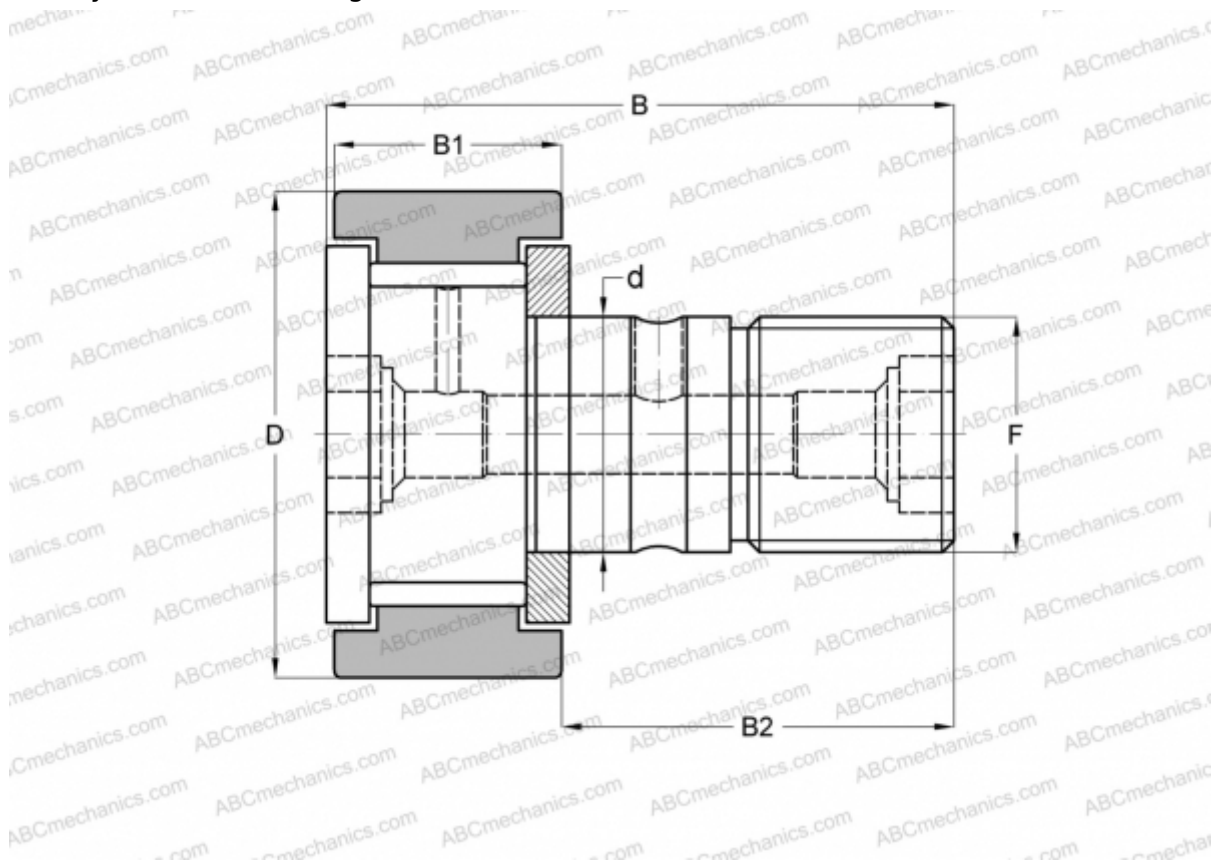

### Technical specification

#### DIMENSIONS, MM

d	18,000
D	40,000
B	58,100
B1	20,000
B2	36,500
F	M18x1.5

**WEIGHT, KG** 0,253

**MANUFACTURER** [IKO](#)

#### INTERCHANGE

ABC	<a href="#">CFKR 40 V</a>
JNS	<a href="#">CF 18 V-AB</a>
THK	<a href="#">CF 18 V-AB</a>

#### CALCULATION DATA

Basic dynamic load rating, C	25,300 kN
Basic static load rating, Co	51,300 kN