

## CF 20 V-AB JNS

Cam followers

TYPE: Roller bearings, Stud type track rollers, With axial guidance, full complement bearing, gap seal on both side, cylindrical outer ring, double hex hole

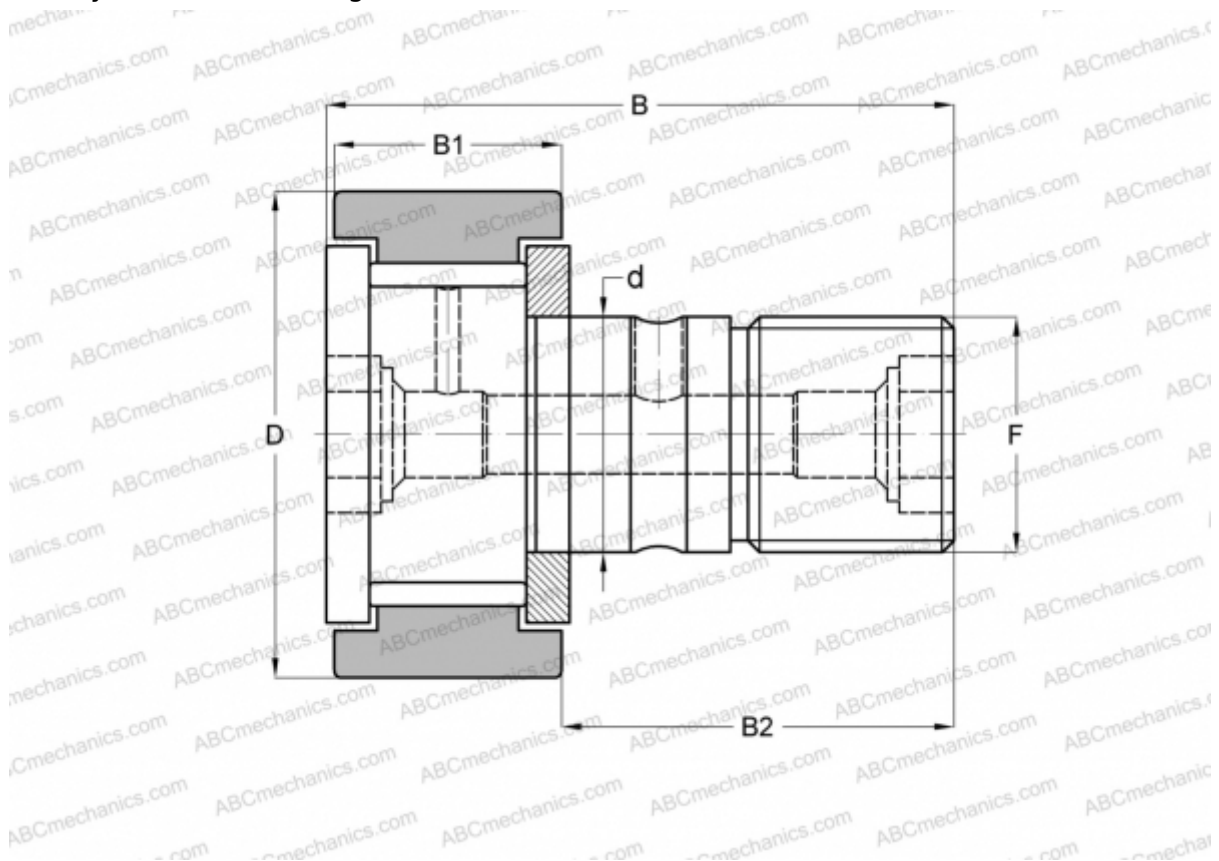

### Technical specification

#### DIMENSIONS, MM

d	20,000
D	52,000
B	66,100
B1	24,000
B2	40,500
F	M20x1.5

**WEIGHT, KG** 0,458

**MANUFACTURER** [JNS](#)

#### INTERCHANGE

ABC	<a href="#">CFKR 52 V</a>
IKO	<a href="#">CFKR 52 V</a>
THK	<a href="#">CF 20 V-AB</a>