

CF 24-1 V-AB JNS

Cam followers

TYPE: Roller bearings, Stud type track rollers, With axial guidance, full complement bearing, gap seal on both side, cylindrical outer ring, double hex hole

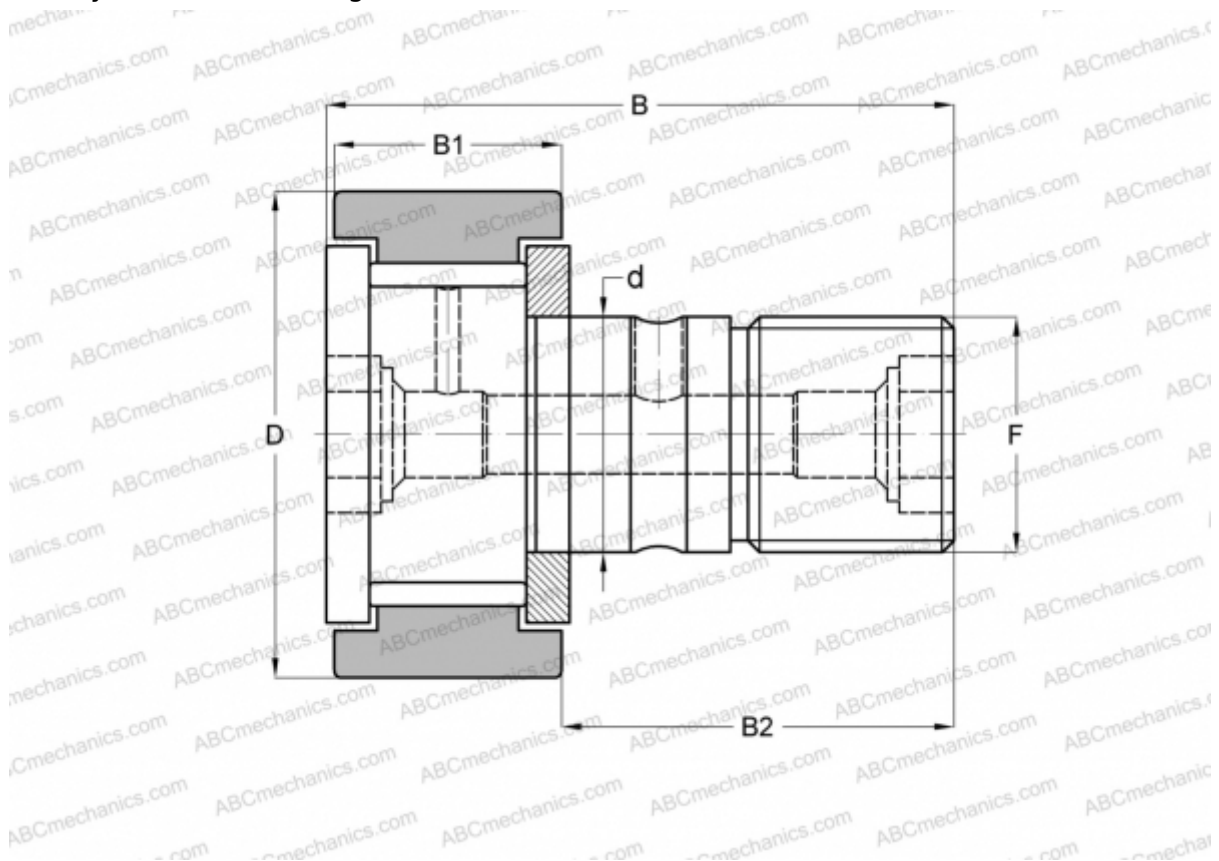

Technical specification

DIMENSIONS, MM

d	24,000
D	72,000
B	80,100
B1	29,000
B2	49,500
F	M24x1.5

WEIGHT, KG 1,120

MANUFACTURER [JNS](#)

INTERCHANGE

ABC	CFKR 72 V
IKO	CFKR 72 V
THK	CF 24-1 V-AB