

CF 30-2 V-AB JNS

Cam followers

TYPE: Roller bearings, Stud type track rollers, With axial guidance, full complement bearing, gap seal on both side, cylindrical outer ring, double hex hole

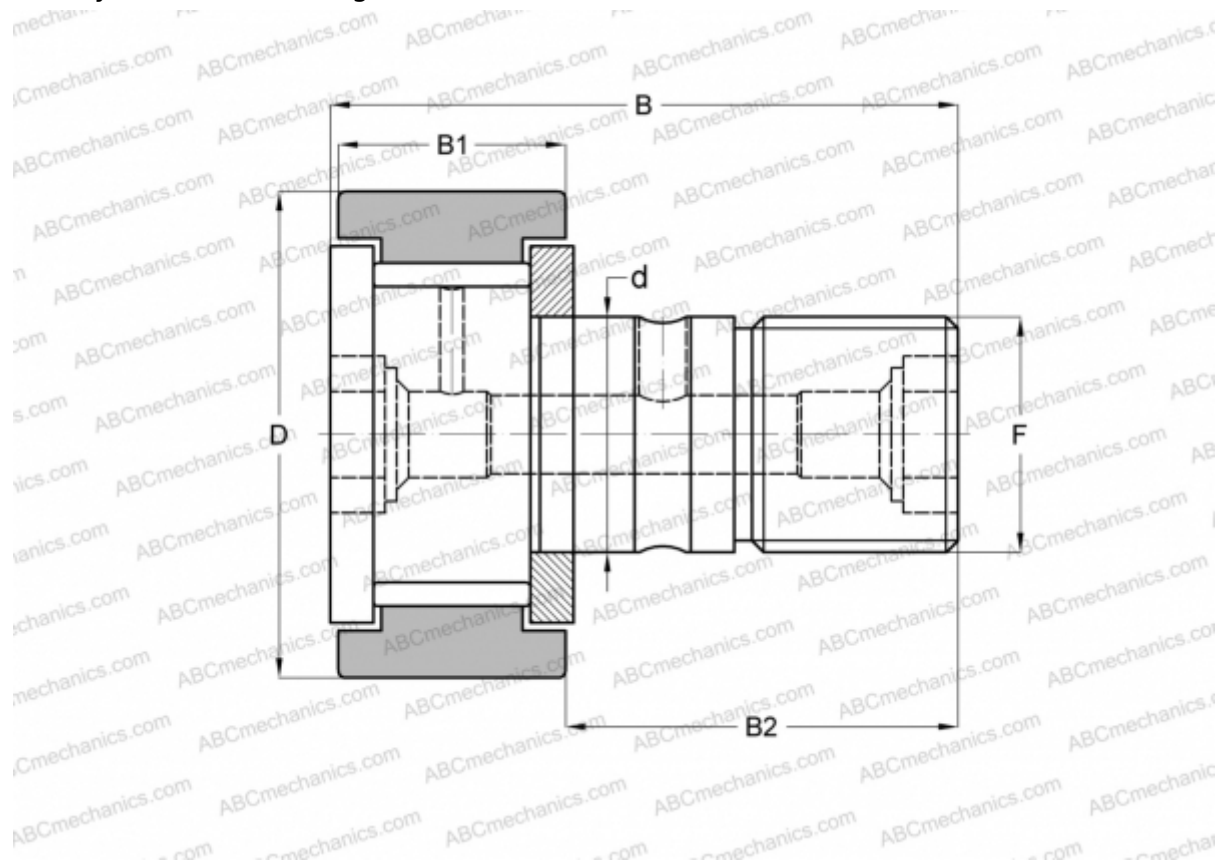

Technical specification

DIMENSIONS, MM

d	30,000
D	90,000
B	100,000
B1	35,000
B2	63,000
F	M30x1.5

WEIGHT, KG 2,210

MANUFACTURER [JNS](#)

INTERCHANGE

ABC	CFKR 90 V
IKO	CFKR 90 V
THK	CF 30-2 V-AB