

## CF 8 VUUR IKO

Cam followers

TYPE: Roller bearings, Stud type track rollers, With axial guidance, full complement bearing, sealing rings on both sides

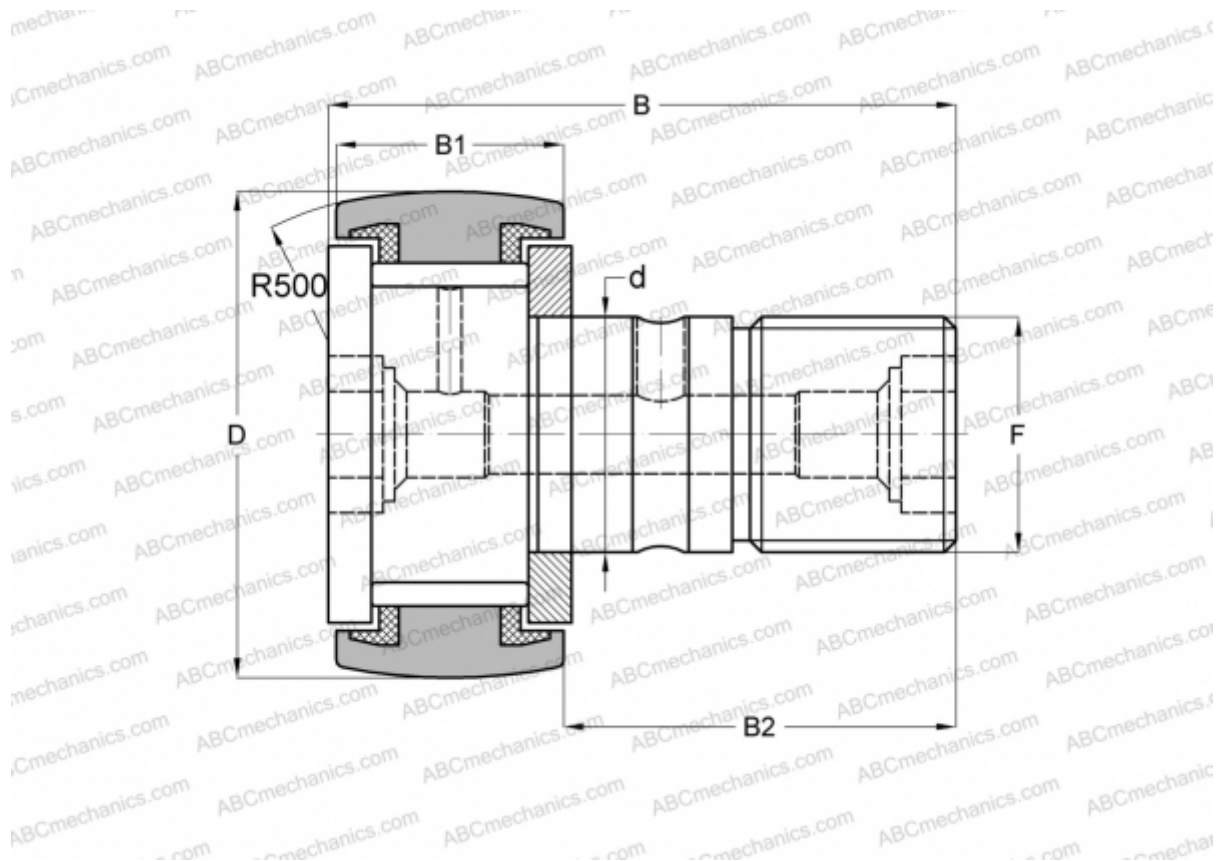

### Technical specification

#### DIMENSIONS, MM

d	8,000
D	19,000
B	32,200
B1	11,000
B2	20,000
F	M8x1.25

**WEIGHT, KG** 0,029

**MANUFACTURER** [IKO](#)

#### INTERCHANGE

ABC	<a href="#">KRV 19 PP</a>
INA	<a href="#">KRV 19 PP A</a>
SKF	<a href="#">KRV 19 PPA</a>
McGill	<a href="#">MCF-19-S</a>

#### CALCULATION DATA

Basic dynamic load rating, C	8,170 kN
Basic static load rating, Co	11,200 kN