

## MCF-19-S McGill

Cam followers

TYPE: Roller bearings, Stud type track rollers, With axial guidance, full complement bearing, sealing rings on both sides

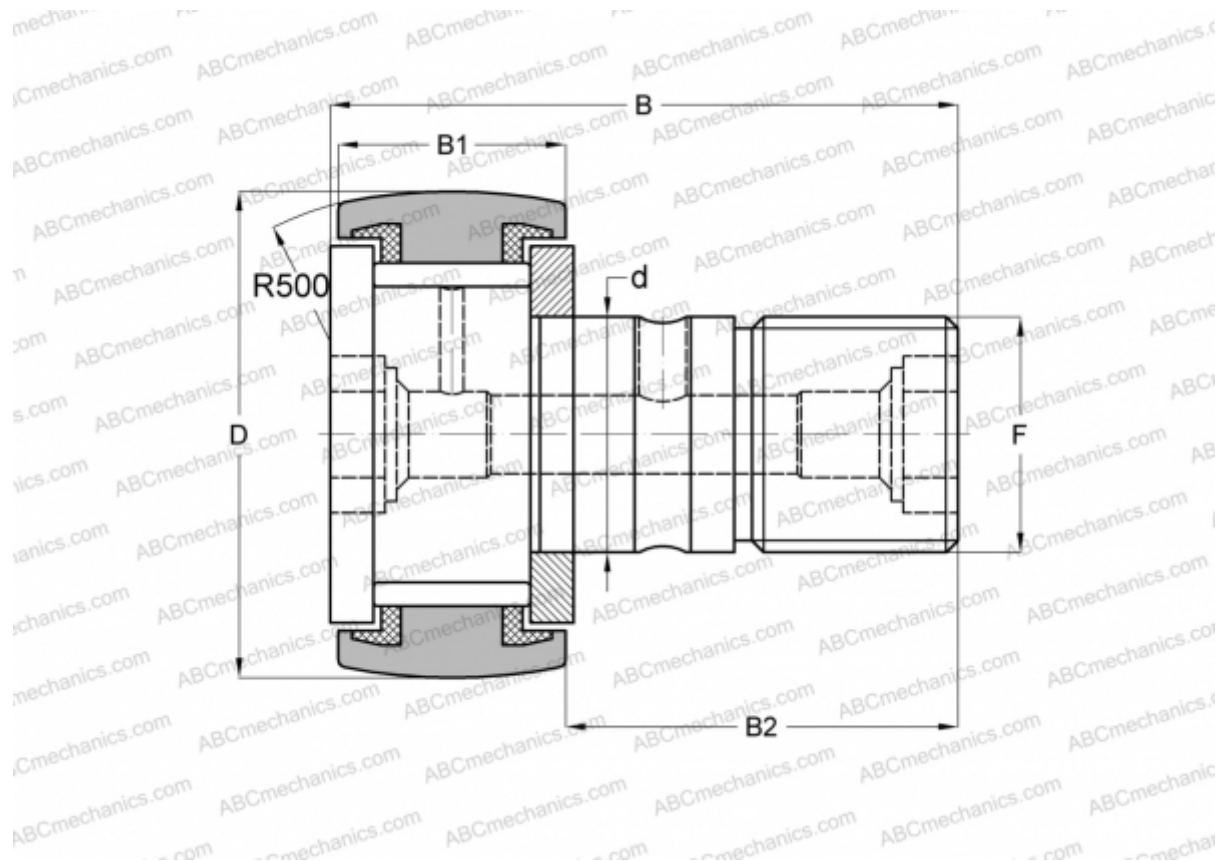

### Technical specification

#### DIMENSIONS, MM

d	8,000
D	19,000
B	32,000
B1	11,000
B2	20,000
F	M8x1.25

**WEIGHT, KG** 0,032

**MANUFACTURER** [McGill](#)

#### INTERCHANGE

ABC	<a href="#">KRV 19 PP</a>
INA	<a href="#">KRV 19 PP A</a>
SKF	<a href="#">KRV 19 PPA</a>
IKO	<a href="#">CF 8 VUUR</a>