

CF 20-1 VUUR IKO

Cam followers

TYPE: Roller bearings, Stud type track rollers, With axial guidance, full complement bearing, sealing rings on both sides

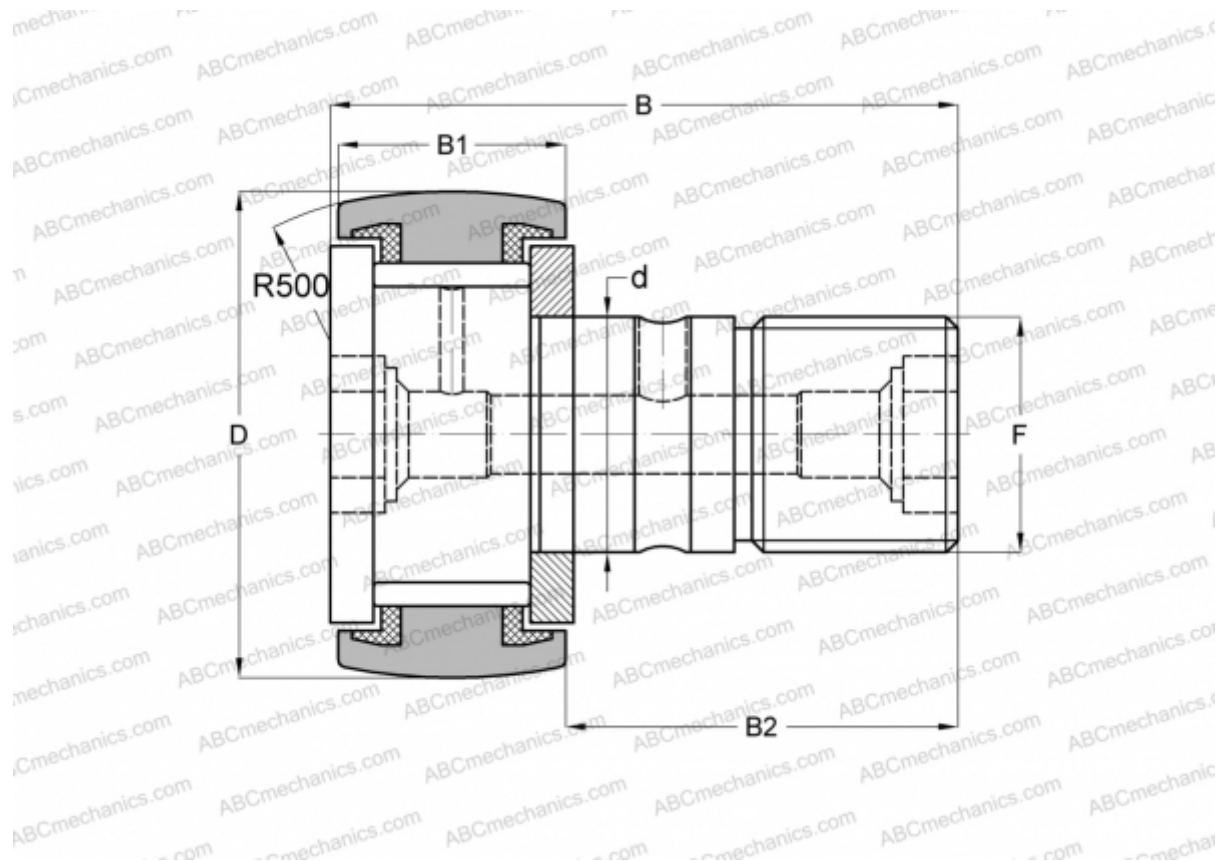

Technical specification

DIMENSIONS, MM

d	20,000
D	47,000
B	66,100
B1	24,000
B2	40,500
F	M20x1.5

WEIGHT, KG 0,390

MANUFACTURER [IKO](#)

INTERCHANGE

ABC	KRV 47 PP
INA	KRV 47 PP A
SKF	KRV 47 PPA
McGill	MCF-47-S

CALCULATION DATA

Basic dynamic load rating, C	33,200 kN
Basic static load rating, Co	64,500 kN