

MCF-62-S McGill

Cam followers

TYPE: Roller bearings, Stud type track rollers, With axial guidance, full complement bearing, sealing rings on both sides

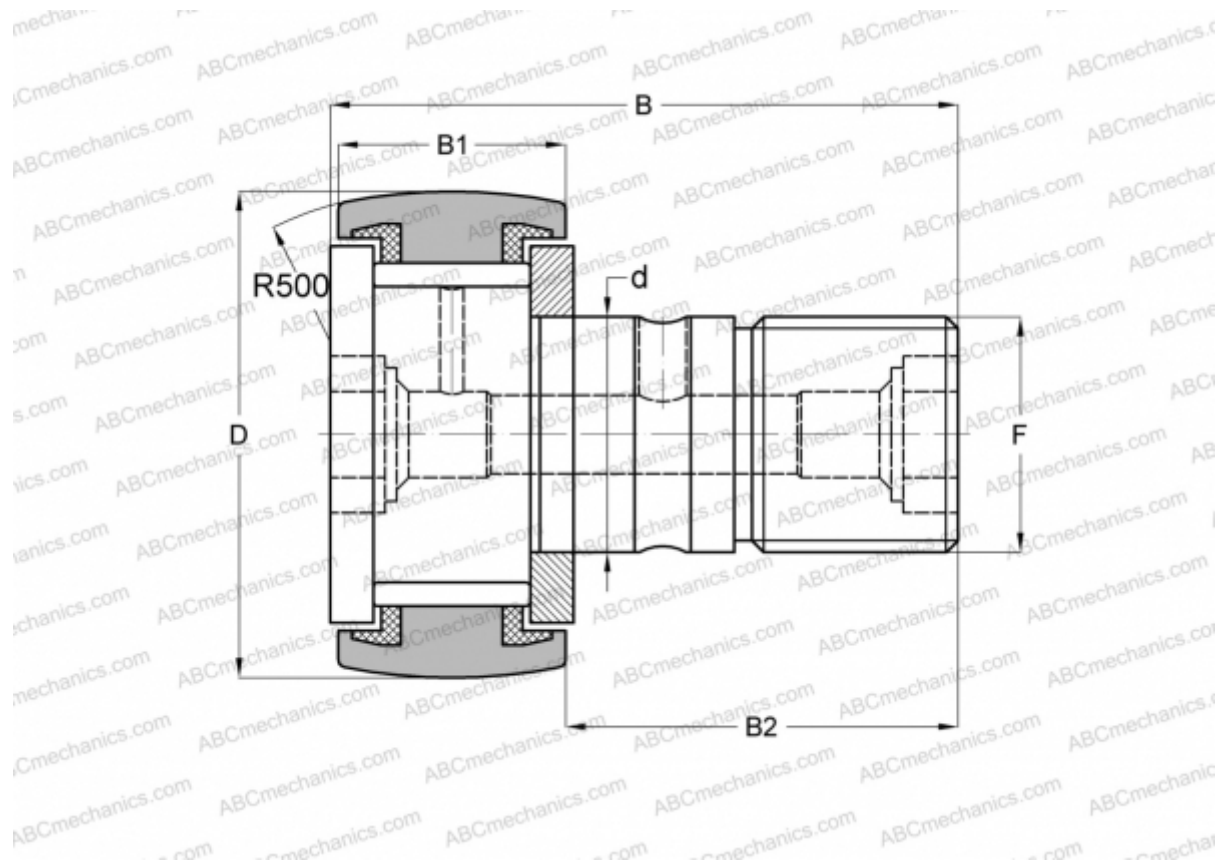

Technical specification

DIMENSIONS, MM

d	24,000
D	62,000
B	80,000
B1	29,000
B2	49,500
F	M24x1.5

WEIGHT, KG 0,798

MANUFACTURER [McGill](#)

INTERCHANGE

ABC	KRV 62 PP
INA	KRV 62 PP A
SKF	KRV 62 PPA
IKO	CF 24 VUUR