

## KRV 72 PP A INA

Cam followers

TYPE: Roller bearings, Stud type track rollers, With axial guidance, full complement bearing, sealing rings on both sides

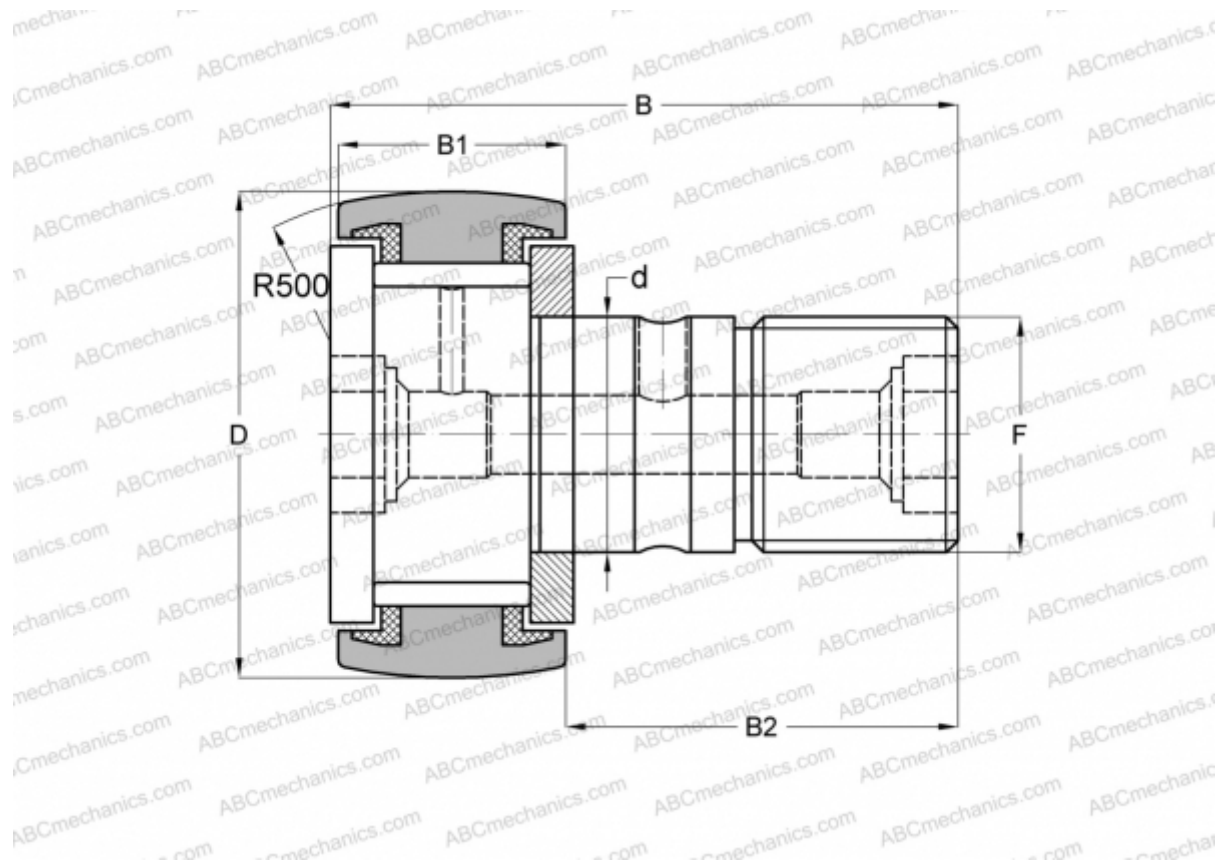

### Technical specification

#### DIMENSIONS, MM

d	24,000
D	72,000
B	80,000
B1	29,000
B2	49,500
F	M24x1.5

**WEIGHT, KG** 1,038

**MANUFACTURER** [INA](#)

#### INTERCHANGE

ABC	<a href="#">KRV 72 PP</a>
SKF	<a href="#">KRV 72 PPA</a>
IKO	<a href="#">CF 24-1 VUUR</a>
McGill	<a href="#">MCF-72-S</a>