

KRV 90 PP ABC

Cam followers

TYPE: Roller bearings, Stud type track rollers, With axial guidance, full complement bearing, sealing rings on both sides

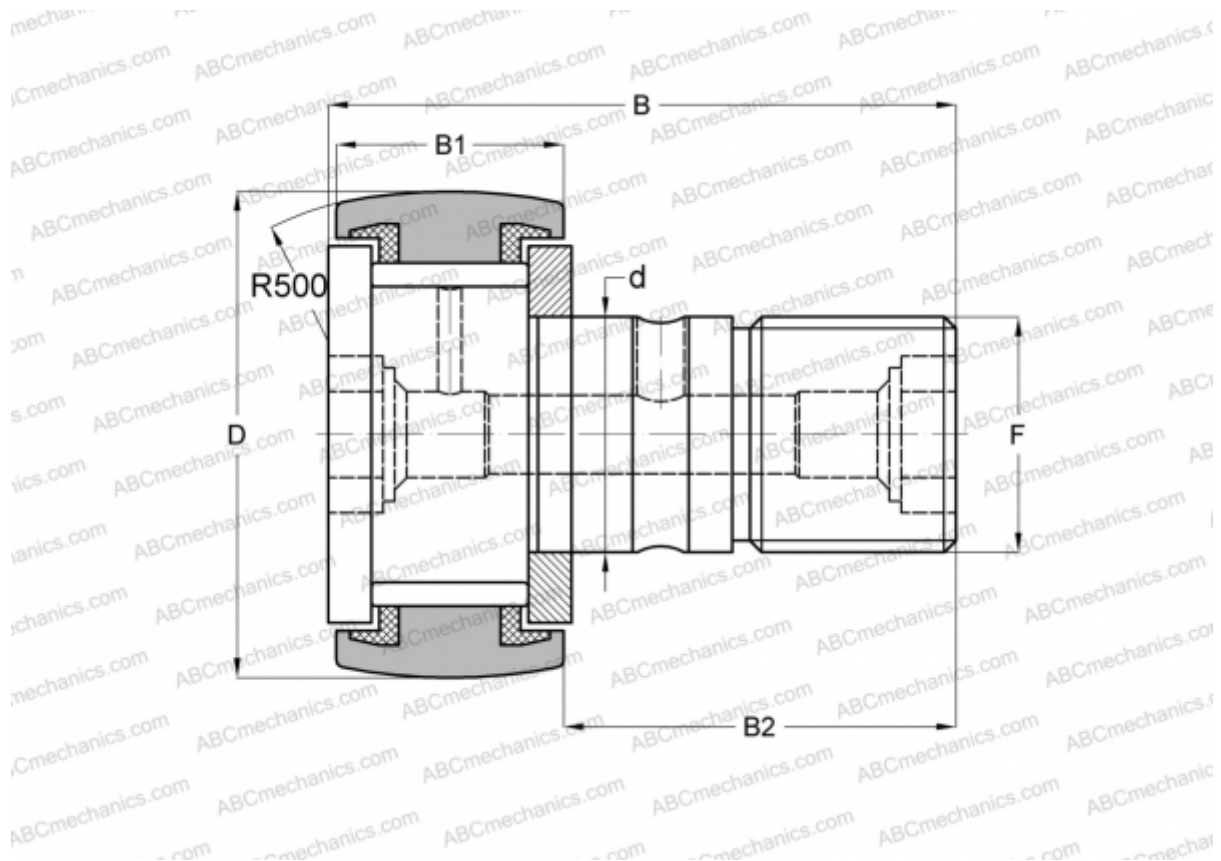

Technical specification

DIMENSIONS, MM

d	30,000
D	90,000
B	100,000
B1	35,000
B2	63,000
F	M30x1.5

WEIGHT, KG 2,032

MANUFACTURER [ABC](#)

INTERCHANGE

INA	KRV 90 PP A
SKF	KRV 90 PPA
IKO	CF 30-2 VUUR
McGill	MCF-90-S