

KRV 19 PPX INA

Cam followers

TYPE: Roller bearings, Stud type track rollers, With axial guidance, full complement bearing, sealing rings on both sides, cylindrical outer ring

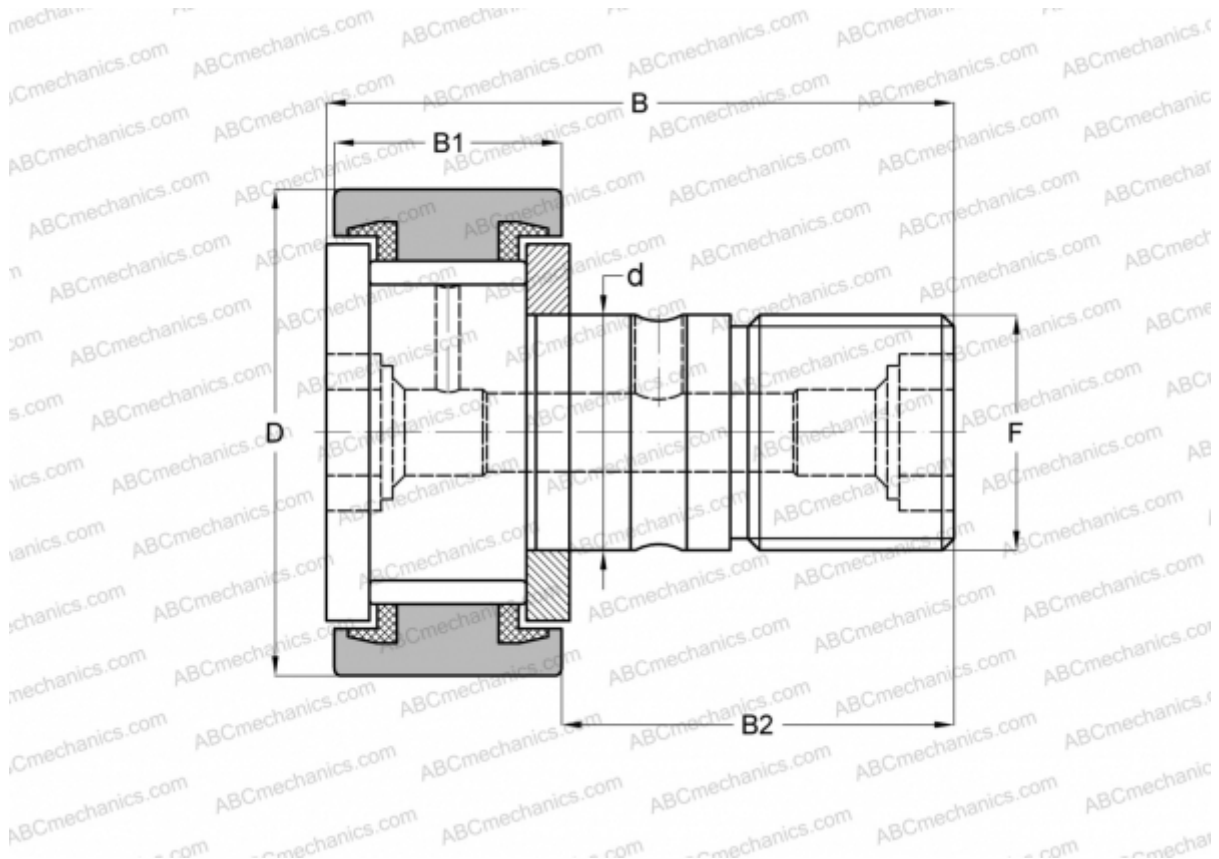

Technical specification

DIMENSIONS, MM

d	8,000
D	19,000
B	32,000
B1	11,000
B2	20,000
F	M8x1.25

WEIGHT, KG 0,032

MANUFACTURER [INA](#)

INTERCHANGE

ABC	KRV 19 PPX
SKF	KRV 19 PPXA
IKO	CF 8 VUU
McGill	MCF-19-SX