

CFKR 26 VUUR IKO

Cam followers

TYPE: Roller bearings, Stud type track rollers, With axial guidance, full complement bearing, sealing rings on both sides, double hex hole

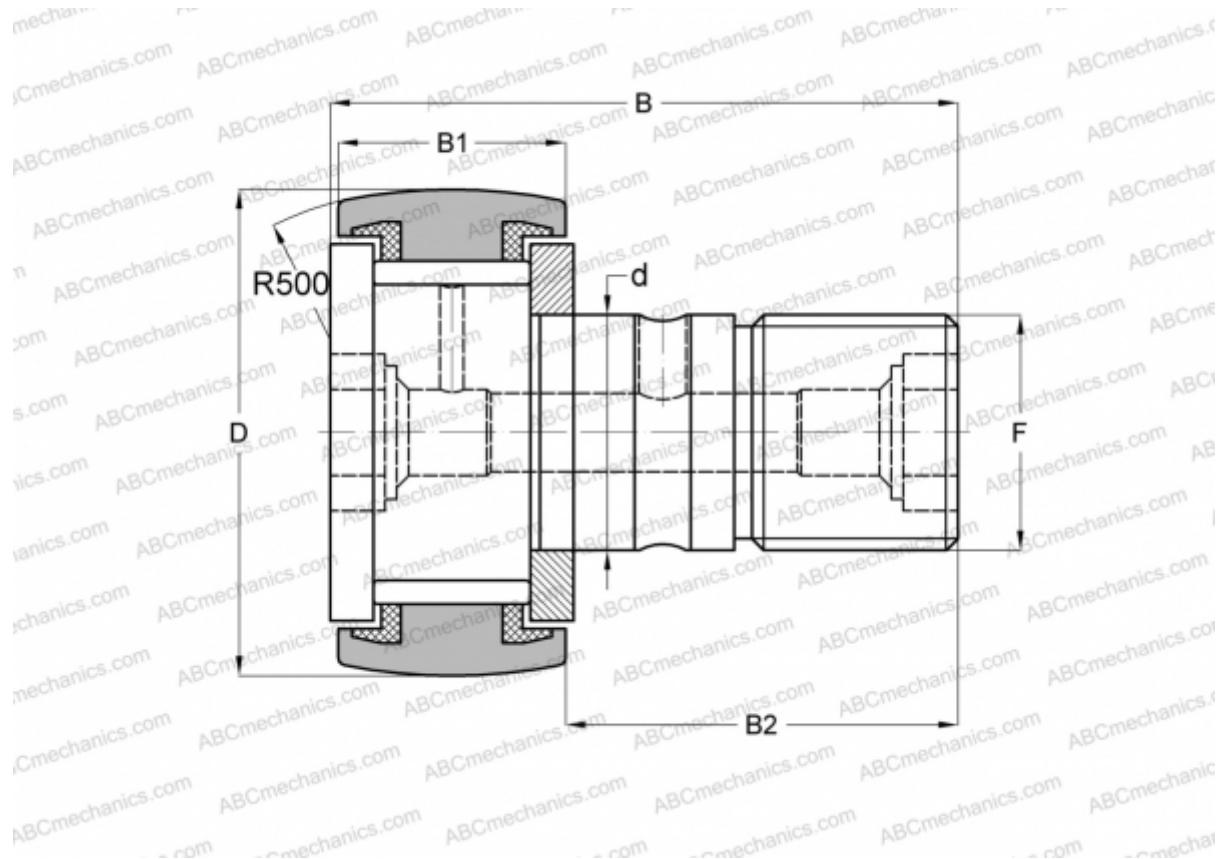

Technical specification

DIMENSIONS, MM

d	10,000
D	26,000
B	36,200
B1	12,000
B2	23,000
F	M10x1.0

WEIGHT, KG 0,059

MANUFACTURER [IKO](#)

INTERCHANGE

ABC [CFKR 26 VUUR](#)

CALCULATION DATA

Basic dynamic load rating, C	9,570 kN
Basic static load rating, Co	14,500 kN