

CF 12-1 VUUR-AB THK

Cam followers

TYPE: Roller bearings, Stud type track rollers, With axial guidance, full complement bearing, sealing rings on both sides, double hex hole

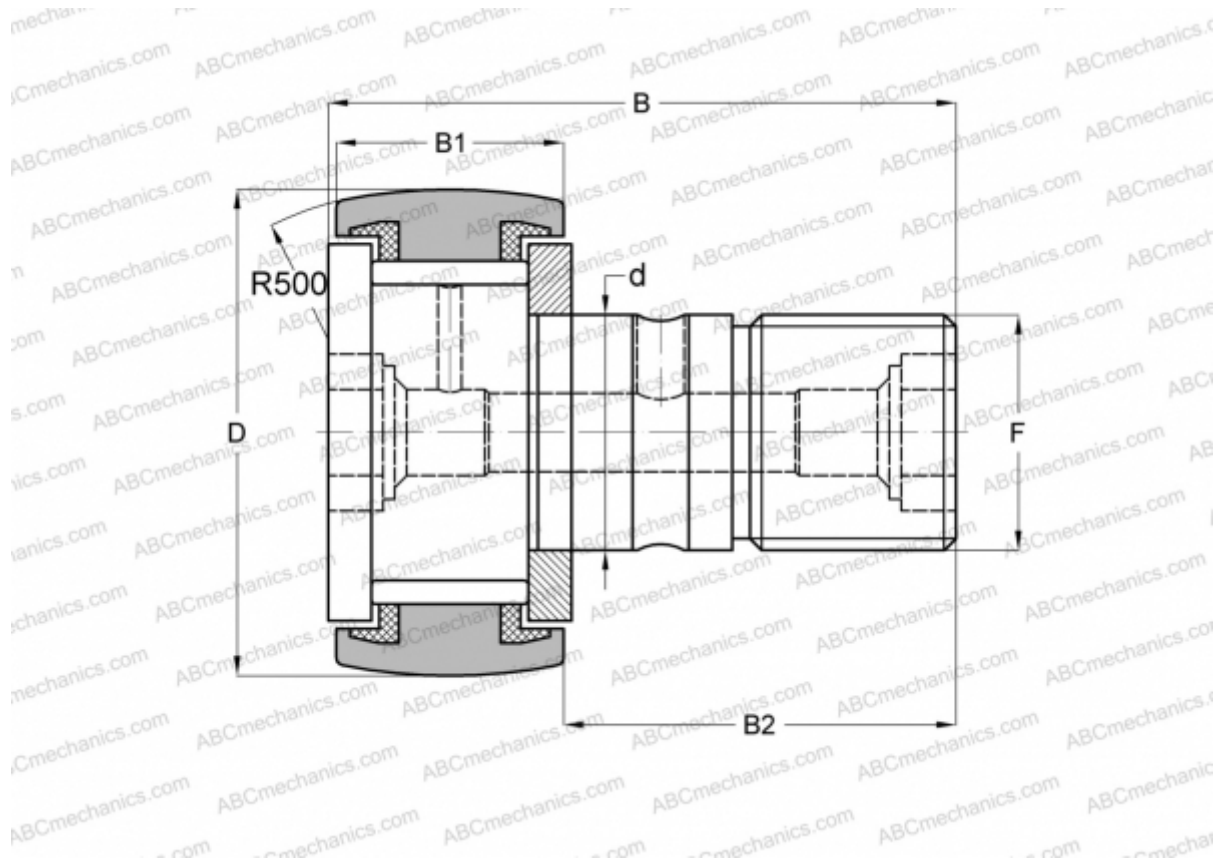

Technical specification

DIMENSIONS, MM

d	12,000
D	32,000
B	40,000
B1	14,000
B2	25,000
F	M12x1.5

WEIGHT, KG 0,100

MANUFACTURER [THK](#)

INTERCHANGE

ABC	CFKR 32 VUUR
IKO	CFKR 32 VUUR
JNS	CF 12-1 VUUR-AB