

CFKR 40 VUUR IKO

Cam followers

TYPE: Roller bearings, Stud type track rollers, With axial guidance, full complement bearing, sealing rings on both sides, double hex hole

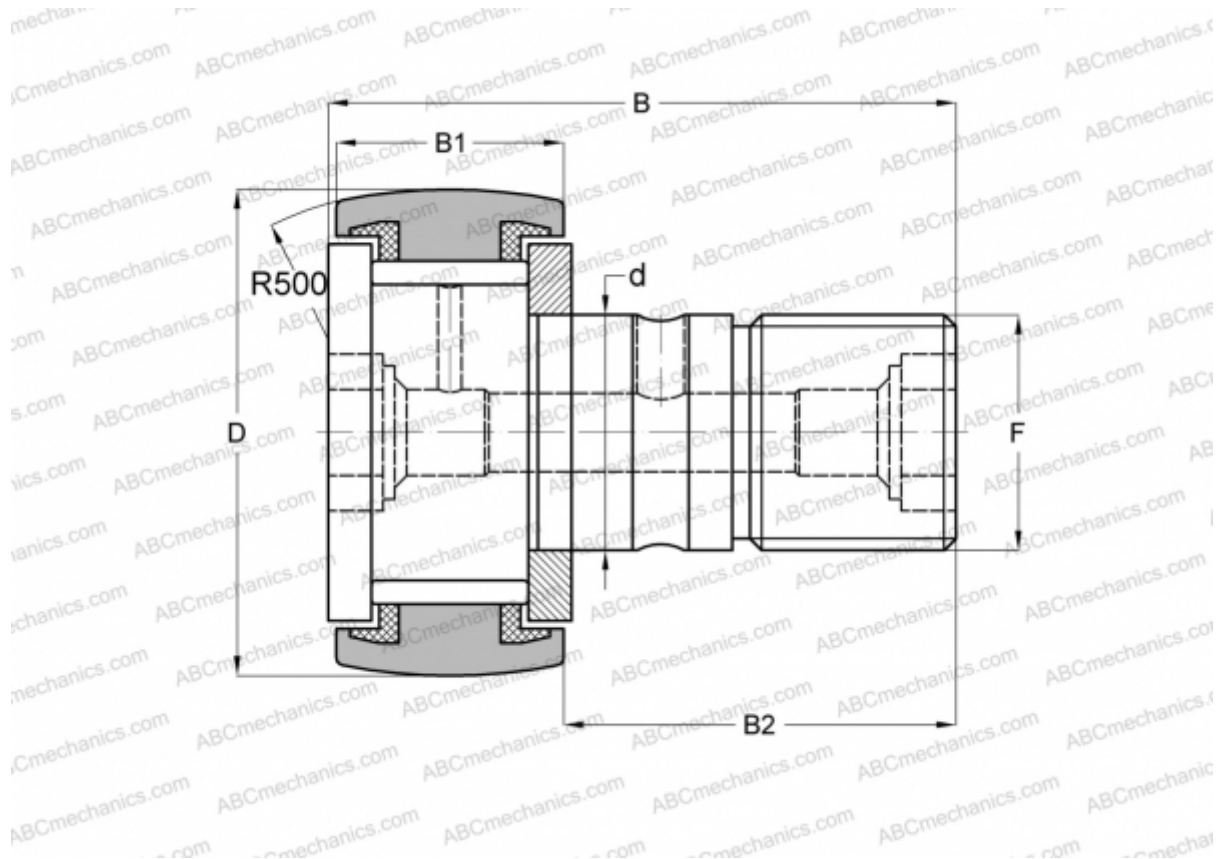

Technical specification

DIMENSIONS, MM

d	18,000
D	40,000
B	58,100
B1	20,000
B2	36,500
F	M18x1.5

WEIGHT, KG 0,253

MANUFACTURER [IKO](#)

INTERCHANGE

ABC	CFKR 40 VUUR
JNS	CF 18 VUUR-AB
THK	CF 18 VUUR-AB

CALCULATION DATA

Basic dynamic load rating, C	25,300 kN
Basic static load rating, Co	51,300 kN