

CF 12 VUU-AB JNS

Cam followers

TYPE: Roller bearings, Stud type track rollers, With axial guidance, full complement bearing, sealing rings on both sides, cylindrical outer ring, double hex hole

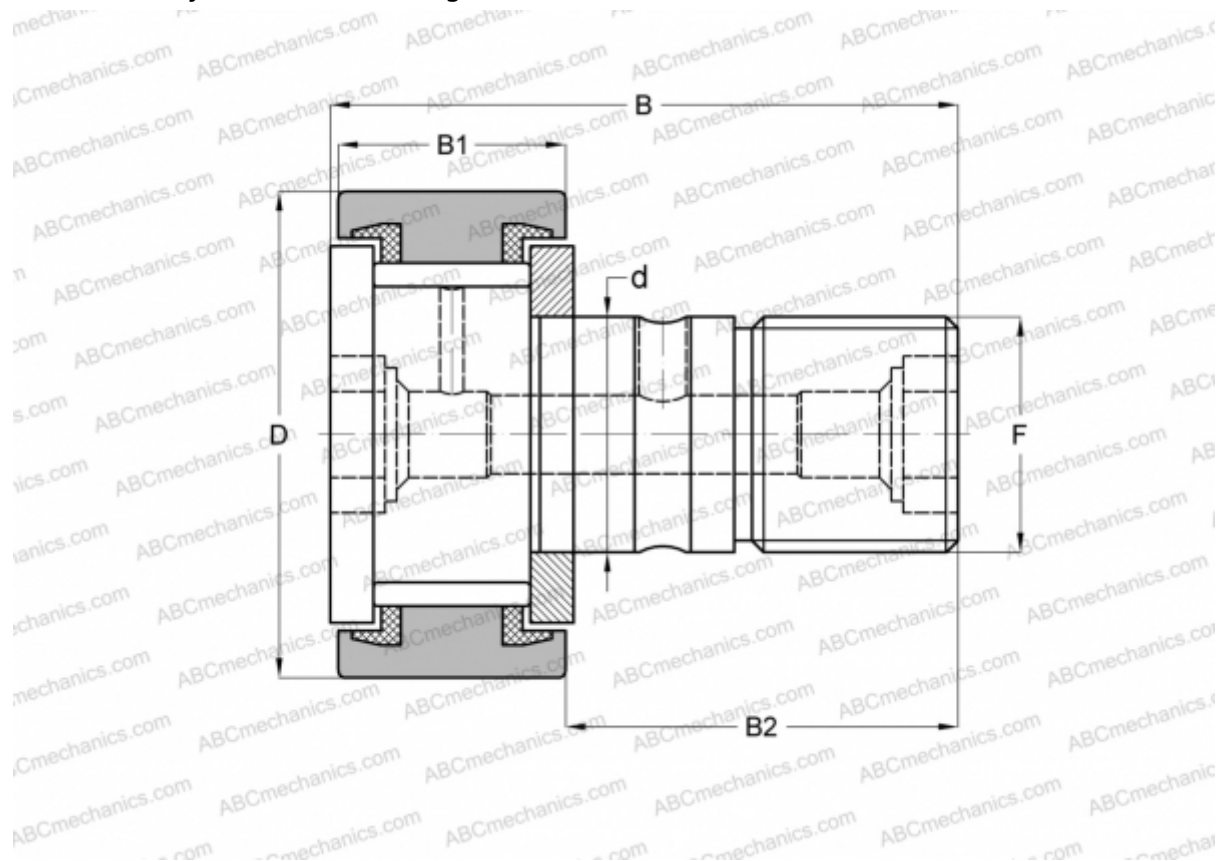

Technical specification

DIMENSIONS, MM

d	12,000
D	30,000
B	40,000
B1	14,000
B2	25,000
F	M12x1.5

WEIGHT, KG 0,091

MANUFACTURER [JNS](#)

INTERCHANGE

ABC	CFKR 30 VUU
IKO	CFKR 30 VUU
THK	CF 12 VUU-AB